



CATÁLOGO DE PRODUCTO



CONTENIDO

1	Aplicaciones de productos	3
2	Tubería	5
	Sanipro	5
	StormTite	6
	SaniTite HP	7
	Green Storm	7
	Subdren Pared Sencilla	8
	Subren Pared Doble	10
	Subdren Pared Doble con Filtro	12
	Low Head (baja presión)	12
	Canalización eléctrica	13
3	Accesorios	18
	Coples para tubos	18
	Lubricante, piezas de reparación	20
	Tapas para inicio de redes y adaptadores	21
	Reductores	23
	Codos	25
	Tee	27
	Tee reductor	28
	Tee reductor / Tee en cruz	30
	Tee en cruz / Silleta	31
	Yee reductora	33
	Accesorios moldeados por inyección	36
	Juego de accesorios reductores moldeados por inyección	39
	Empaques	40
	Inserta Tee	41
	Sierra circular para conexión Inserta Tee®	43
	Coples	44
	Tapas y tapones	45
	Adaptador y bajante / Tubería flexible Bend-A-Drain™	46
	Reductores y codos para tubería flexible	47
	Tee	48
	Yee	50
	Accesorios	51
	Turf Flow®	51
4	Nyloplast - Estructuras / registros subterráneos	52
	Estructuras de captación con rejillas para banqueta	52
	Estructura captación	53
	Coladoera para estructura de captación	53
	Opciones de rejillas para las estructuras Nyloplast®	54
	Tapa de rejilla sobrepuesta	54
	Estructura de control de agua	55
	Sumideros	55
	Casquillo entrada a estructura	55
	Coples y adaptadores	56
	Yee	58
	Tee barrida y reductor	59
	Codos	60
	Registro pluvial / Pozo de visita	61

CONTENIDO

5	Elevadores Hickenbottom®	62
6	Cabezales plásticos para alcantarilla	64
7	Sistemas de retención y detención	66
	Accesorios Landmax.....	66
	Cámaras StormTech®.....	70
	Accesorios StormTech®	71
	Codos StormTech®	73
	Accesorios StormTech®	74
8	Tratamiento de agua pluvial	81
	Unidades de Calidad de Agua	81
	Flexstorm® Pure	82
	Flexstorm® Catch It	83
	Filtros de Nyloplast®, repuesto de bolsas y accesorios	84
	Insertos de captura de residuos	85
	Pantalla de tubería de concreto	86
	Baysaver pretratamiento de agua pluvial	87
9	Duraslot®	88
	Duraslot® (imbornal) captación de escurrimiento superficial	88
	Accesorios para Duraslot®.....	89
10	Advanedge	92
	Accesorios	93
11	Biodifusores	94
	ARC™ Cámaras y accesorios	94
	Biodiffuser® y accesorios	95
12	Sistemas Sépticos	96
13	Accesorios para regulación de aguas residuales	97
14	Sumideros y accesorios	98
15	Registros y empaques tipo “waterstop”	99
16	Geosintéticos	100
	Geosintéticos no tejido	100
	Geosintéticos tejido y geomalla	101
	Geosintéticos tela septica	102
	Geosintéticos manta, alfombra, vallas, alfileres de tela	103

	Unidad de Negocio	Tipo de producto	Rango de diámetros	Marca
Tubería	Infra	DW-WT AASHTO	04" - 60"	Stormtite
	Infra	DW-WT SCT/HIGHWAY	04" - 60"	Stormtite
	Infra	DW-NMX 241	04" - 60"	Sanipro
	Infra	DW-ASTM 2648	15" - 60"	Green Storm
	Infra	DW-VIVIENDA	04" - 12"	
	Infra	DW-SUBDREN MG	02" - 12" solid & perf	Subdren doble pared
	WP	DW-Conduit Sticks	02" - 12"	
	WP	DW- Conduit Coils	1 1/2" - 08"	
	WP	DW- Telcom Coils	1 1/2" - 08"	
	WP	PVC Pipe	13 mm - 110 mm	
	Infra	Single Wall	02" - 24"	Subdren pared sencilla
	Infra	SanitTite HP	30" - 60"	Sanitite
	Infra	HP Storm	06" - 60"	HP Storm
	Infra	ADS Triple Wall Smoothwall	03" - 04"	
	Infra	Low Head Pipe	30" - 60"	Low Head Pipe
	Infra	ADS PolyFlex (solid wall)	-	
	Infra	Duraslot	4" - 36"	Duraslot
	Infra	AdvanEdge	12" & 18"	AdvanEdge
Infra	Bend-A-Drain	-	Bend-A-Drain	
Accesorios	Infra	Single Wall Fittings		
	Infra	Dual Wall Fittings		
	Infra	Inserta Tee		
	Infra	Bend-A-Drain		
	WP	PVC Fittings for Conduit		
Estructuras	Infra	Nyloplast Drainage Structures		
	Infra	StormTech Chambers		
Unidades de Calidad de Agua	Infra	Tanques Unidad Calidad Agua		Tanques Unidad Calidad Agua
	Infra	Bay Filter		Bay Filter
	Infra	Streamfilter		Streamfilter
	Infra	Trampas de Grasa		Trampas de Grasa
	Infra	Bay Separator		Bay Separator
	Infra	Barracuda		Barracuda
	Infra	Flextrom		Flextrom
	Infra	EnviroHood		EnviroHood
Sistemas Septicos	Infra	ARC Chambers		
	Infra	BioDiffuser Chamber		
	Infra	SB2		
	Infra	Septic Stack Systems		
	Infra	Onsite Drainage Products		
	Infra	Perimeter Drain Products		
Geotextiles & Control de Erosión	Infra	Geotextiles		
	Infra	Geogrids		
	Infra	Silt Fence		
	Infra	Erosion Control		

Serie 31

Descripción	Código
06" TUBERIA DW SERIE 31 [6.110 ML] CAMPANA SOLIDO ASTM F 2947-12	06310020IB
08" TUBERIA DW SERIE 31 [6.10 ML] CAMPANA SOLIDO ASTM F 2947-12	08310020IB
10" TUBERIA DW.SERIE 31.[6.10 ML]. CAMPANA.SOLIDO.ASTM F 2947-12	10310020IB
12" TUBERIA DW.SERIE 31.[6.02 ML]. CAMPANA.SOLIDO.ASTM F 2947-12	12310020IB30
15" TUBERIA DW.SERIE 31.[6.08 ML]. CAMPANA.SOLIDO.ASTM F 2947-12	15310020IB30
18" TUBERIA DW.SERIE 31.[5.96 ML]. CAMPANA.SOLIDO.ASTM F 2947-12	18310020IB30
24" TUBERIA DW.SERIE 31.[6.04 ML]. CAMPANA.SOLIDO.ASTM F 2947-12	24310020IB30
30" TUBERIA DW.SERIE 31.[6.13 ML]. CAMPANA.SOLIDO.ASTM F 2947-12	30310020IB
36" TUBERIA DW.SERIE 31.[6.00 ML]. CAMPANA.SOLIDO.ASTM F 2947-12	36310020IB
42" TUBERIA DW.SERIE 31.[6.050 ML]. CAMPANA.SOLIDO.ASTM F 2947-12	42310020IB
48" TUBERIA DW.SERIE 31.[6.02 ML]. CAMPANA.SOLIDO.ASTM F 2947-12	48310020IB

Serie 32

Descripción	Código
04" TUB. NMX-E-241 SN MIN4 [6.12 ML]	04320020IB4
06" TUB. NMX-E-241 SN MIN4 [6.10 ML]	06320020IB4
08" TUB. NMX-E-241 SN MIN4 [5.92 ML]	08320019.4IB4
10" TUB. NMX-E-241 SN MIN4 [6.10 ML]	10320020IB4
12" TUB. NMX-E-241 SN MIN4 [6.09 ML]	12320020IB304
15" TUB. NMX-E-241 SN MIN4 [6.08 ML]	15320020IB304
18" TUB. NMX-E-241 SN MIN4 [5.96 ML]	18320020IB304
24" TUB. NMX-E-241 SN MIN4 [6.11 ML]	24320020IB304
30" TUB. NMX-E-241 SN MIN4 [6.13 ML]	30320020IB304
36" TUB. NMX-E-241 SN MIN2 [6.00 ML]	36320020IB2
42" TUB. NMX-E-241 SN MIN2 [6.05 ML]	42320020IB2
48" TUB. NMX-E-241 SN MIN2 [6.02 ML]	48320020IB2
60" TUB. NMX-E-241 SN MIN2 [6.02 ML]	60320020IB2

Serie 30	
Descripción	Código
04".TUBERIA DW.SERIE 30.[6.120 ML].CAMPANA.SOLIDO.AASHTO M252-09.STORMTITE	04300020IB
06".TUBERIA DW.SERIE 30.[6.100 ML].CAMPANA.SOLIDO.INCLUYE 1 EMPAQUE. AASHTO M252-09.STORMTITE	06300020IB
08".TUBERIA DW.SERIE 30.[6.100 ML].CAMPANA.SOLIDO AASHTO M252-09.STORMTITE	08300020IB
10".TUBERIA DW.SERIE 30.[6.100 ML].CAMPANA.SOLIDO. INCLUYE 1 EMPAQUE.AASHTO M252-09..STORMTITE	10300020IB
12".TUBERIA DW.SERIE 30.[6.090 ML].CAMPANA.SOLIDO AASHTO M294-13.STORMTITE	12300020IB30
15".TUBERIA DW.SERIE 30.[6.160 ML].CAMPANA.SOLIDO.INCLUYE 1 EMPAQUE.AASHTO M294-13.STORMTITE	15300020IB30
18".TUBERIA DW.SERIE 30.[6.020 ML].CAMPANA.SOLIDO.INCLUYE 2 EMPAQUES.AASHTO M294-13.STORMTITE	18300020IB30
24".TUBERIA DW.SERIE 30.[6.180 ML].CAMPANA.SOLIDO.INCLUYE 2 EMPAQUES.AASHTO M294-13.STORMTITE	24300020IB30
30".TUBERIA DW.SERIE 30.[6.170 ML].CAMPANA.SOLIDO.INCLUYE 2 EMPAQUES. AASHTO M294-13.STORMTITE	30300020IB30
36".TUBERIA DW.SERIE 30.[6.010 ML].CAMPANA.SOLIDO.INCLUYE 2 EMPAQUES. AASHTO M294-13.STORMTITE	36300020IB
42".TUBERIA DW.SERIE 30.[6.050 ML].CAMPANA.SOLIDO.AASHTO M294-13.STORMTITE	42300020IB
48".TUBERIA DW.SERIE 30.[6.040 ML].CAMPANA.SOLIDO.INCLUYE 2 EMPAQUES. AASHTO M294-13.STORMTITE	48300020IB
60".TUBERIA DW.SERIE 30.[6.040 ML].CAMPANA.SOLIDO.AASHTO M294-13.STORMTITE	60300020IB

Serie 30 Doble Pared

Descripción	Código
12".TUBERIA DW.SERIE 30.[6.100 ML].CAMPANA.SOLIDO POLIPROPILENO SANITARIO	12300020IBPPZ
15".TUBERIA DW.SERIE 30.[6.100 ML].CAMPANA.SOLIDO POLIPROPILENO SANITARIO	15300020IBPPZ
18".TUBERIA DW.SERIE 30.[6.100 ML].CAMPANA.SOLIDO POLIPROPILENO SANITARIO	18300020IBPPZ
24".TUBERIA DW.SERIE 30.[6.100 ML].CAMPANA.SOLIDO POLIPROPILENO SANITARIO	24300020IBPPZ
30".TUBERIA N-12.SERIE 30.[6.100 ML].CAMPANA.SOLIDO POLIPROPILENO SANITARIO	30300020IBHPZ

Serie 30 Triple Pared

Descripción	Código
30".TUBERIA DW.SERIE 30.[6.100 ML].CAMPANA.SOLIDO POLIPROPILENO SANITARIO	30300020IBPPZ
36".TUBERIA N-12.SERIE 30.[6.100 ML].CAMPANA.SOLIDO POLIPROPILENO SANITARIO	36300020IBHPZ
42".TUBERIA N-12.SERIE 30.[6.100 ML].CAMPANA.SOLIDO POLIPROPILENO SANITARIO	42300020IBHPZ
48".TUBERIA N-12.SERIE 30.[6.100 ML].CAMPANA.SOLIDO POLIPROPILENO SANITARIO	48300020IBHPZ
60".TUBERIA N-12.SERIE 30.[6.100 ML].CAMPANA.SOLIDO POLIPROPILENO SANITARIO	60300020IBHPZ

Green Storm

Serie 37

Descripción	Código
04" TUBERIA PLUVIAL PRIVADA - SN 4, 6.09 m	04370020IB
06" TUBERIA PLUVIAL PRIVADA - SN 4, 6.09 m	06370020IB4
08" TUBERIA PLUVIAL PRIVADA - SN 4, 5.92 m	08370019.4IB4
10" TUBERIA PLUVIAL PRIVADA - SN 4, 6.09 m	10370020IB
12" TUBERIA PLUVIAL PRIVADA - SN 4, 6.02 m	12370020IB304
15" TUBERIA PLUVIAL PRIVADA - SN 5, 6.16 m	15370020IB30
18" TUBERIA PLUVIAL PRIVADA - SN 5, 6.02 m	18370020IB30
24" TUBERIA PLUVIAL PRIVADA - SN 5, 6.18 m	24370020IB30
30" TUBERIA PLUVIAL PRIVADA - SN 5, 6.17 m	30370020IB30
36" TUBERIA PLUVIAL PRIVADA - SN 4, 6.01 m	36370020IB
42" TUBERIA PLUVIAL PRIVADA - SN 4, 6.05 m	42370020IB
48" TUBERIA PLUVIAL PRIVADA - SN 3, 6.04 m	48370020IB
60" TUBERIA PLUVIAL PRIVADA - SN 2, 6.04 m	60370020IB

Serie 01

Descripción	Código
03".TUBERIA SW.SERIE 01.[1524 ML].DESNUDO.PERFORADO AGRICOLA	03015000
04".TUBERIA SW.SERIE 01.[30.480 ML].DESNUDO.PERFORADO AGRICOLA	04010100
04".TUBERIA SW.SERIE 01.[76.200 ML].DESNUDO.PERFORADO AGRICOLA	04010250
06".TUBERIA SW.SERIE 01.[6.096 ML].DESNUDO.PERFORADO AGRICOLA	06010020
06".TUBERIA SW.SERIE 01.[30.480 ML].DESNUDO.PERFORADO AGRICOLA	06010100
06".TUBERIA SW.SERIE 01.[399.593 ML].DESNUDO.PERFORADO AGRICOLA	06011311
08".TUBERIA SW.SERIE 01.[6.100 ML].DESNUDO.PERFORADO AGRICOLA	08010020
08".TUBERIA SW.SERIE 01.[12.200 ML].DESNUDO.PERFORADO AGRICOLA	08010040
08".TUBERIA SW.SERIE 01.[180 ML].DESNUDO.PERFORADO AGRICOLA	08010592
10".TUBERIA SW.SERIE 01.[6.100 ML].DESNUDO.PERFORADO AGRICOLA	10010020

Serie 03

Descripción	Código
12".TUBERIA SW.SERIE 03.[6.100 ML].DESNUDO.PERFORADO AGRICOLA	12010020
15".TUBERIA SW.SERIE 03.[6.100 ML].DESNUDO.PERFORADO AGRICOLA	15010020
18".TUBERIA SW.SERIE 03.[6.100 ML].DESNUDO.PERFORADO AGRICOLA	18010020
24".TUBERIA SW.SERIE 03.[6.100 ML].DESNUDO.PERFORADO AGRICOLA	24010020

Serie 43

Descripción	Código
03".TUBERIA SW.SERIE 43.[30.480 ML].PERFORADO CON FILTRO	03430100
04".TUBERIA SW.SERIE 43.[30.480 ML].PERFORADO CON FILTRO	04430100
04".TUBERIA SW.SERIE 43.[76.200 ML].PERFORADO CON FILTRO	04430250
04".TUBERIA SW.SERIE 43.[917.400 ML].PERFORADO CON FILTRO	04433000
06".TUBERIA SW.SERIE 43.[6.096 ML].PERFORADO CON FILTRO	06430020
06".TUBERIA SW.SERIE 43.[30.480 ML].PERFORADO CON FILTRO	06430100
06".TUBERIA SW.SERIE 43.[399.57 ML].PERFORADO CON FILTRO	06431311
08".TUBERIA SW.SERIE 43.[6.100 ML].PERFORADO CON FILTRO	08430020
08".TUBERIA SW.SERIE 43.[12.200 ML].PERFORADO CON FILTRO	08430040
08".TUBERIA SW.SERIE 43.[180 ML].PERFORADO CON FILTRO	08430592
10".TUBERIA SW.SERIE 43.[6.100 ML].PERFORADO CON FILTRO	10430020

Serie 45

Descripción	Código
12".TUBERIA SW.SERIE 45.[6.100 ML].PERFORADO CON FILTRO	12430020
15".TUBERIA SW.SERIE 45.[6.100 ML].PERFORADO CON FILTRO	15430020
18".TUBERIA SW.SERIE 45.[6.100 ML].PERFORADO CON FILTRO	18430020
24".TUBERIA SW.SERIE 45.[6.100 ML].PERFORADO CON FILTRO	24430020

Serie 51	
Descripción	Código
03".TUBERIA SW.SERIE 51.[30.480 ML].DESNUDO.SOLIDO AGRICOLA	03510100
03".TUBERIA SW.SERIE 51.[100 ML].DESNUDO.SOLIDO AGRICOLA	03510335
03".TUBERIA SW.SERIE 51.[1524 ML].DESNUDO.PERFORADO AGRICOLA	03515000
04".TUBERIA SW.SERIE 51.[30.480 ML].DESNUDO.SOLIDO AGRICOLA	04510100
04".TUBERIA SW.SERIE 51.[76.200 ML].DESNUDO.SOLIDO AGRICOLA	04510250
04".TUBERIA SW.SERIE 51.[917.400 ML].DESNUDO.SOLIDO AGRICOLA	04513000
06".TUBERIA SW.SERIE 51.[30.480 ML].DESNUDO.SOLIDO AGRICOLA	06510100
06".TUBERIA SW.SERIE 51.[399.593 ML].DESNUDO.SOLIDO AGRICOLA	06511311
08".TUBERIA SW.SERIE 51.[6.096 ML].DESNUDO.SOLIDO AGRICOLA	08510020
08".TUBERIA SW.SERIE 51.[12.200 ML].DESNUDO.SOLIDO AGRICOLA	08510040
08".TUBERIA SW.SERIE 51.[180 ML].DESNUDO.SOLIDO AGRICOLA	08510592
10".TUBERIA SW.SERIE 51.[6.096 ML].DESNUDO.SOLIDO AGRICOLA	10510020
12".TUBERIA SW.SERIE 51.[6.096 ML].DESNUDO.SOLIDO AGRICOLA	12510020
15".TUBERIA SW.SERIE 51.[6.096 ML].DESNUDO.SOLIDO AGRICOLA	15510020
18".TUBERIA SW.SERIE 51.[6.096 ML].DESNUDO.SOLIDO AGRICOLA	18510020
24".TUBERIA SW.SERIE 51.[6.096 ML].DESNUDO.SOLIDO AGRICOLA	24510020

Serie 11

Descripción	Código
04".TUBERIA DW.SERIE 11.[6.130 ML].DESNUDO.PERFORADO SUBDREN	04110020
04".TUBERIA DW.SERIE 11.[6.130 ML].CAMPANA.PERFORADO SUBDREN	04110020IB
06".TUBERIA DW.SERIE 11.[6.110 ML].DESNUDO.PERFORADO SUBDREN	06110020
06".TUBERIA DW.SERIE 11.[6.110 ML].CAMPANA.PERFORADO SUBDREN	06110020IB
08".TUBERIA DW.SERIE 11.[6.100 ML].CAMPANA.PERFORADO SUBDREN	08110020IB
10".TUBERIA DW.SERIE 11.[6.100 ML].DESNUDO.PERFORADO SUBDREN	10110020
10".TUBERIA DW.SERIE 11.[6.100 ML].CAMPANA.PERFORADO SUBDREN	10110020IB

Serie 12

Descripción	Código
04".TUBERIA DW.SERIE 12.[6.130 ML].CAMPANA.PERFORADO.MEDIA CANA.SUBDREN	04120020IB
06".TUBERIA DW.SERIE 12.[6.110 ML].DESNUDO.PERFORADO SUBDREN	06120020
06".TUBERIA DW.SERIE 12.[6.110 ML].CAMPANA.PERFORADO. MEDIA CANA.SUBDREN	06120020IB
06".TUBERIA DW.SERIE 12.[6.110 ML].CAMPANA .PERFORADO ESPECIAL.MEDIA CAÑA	06120020IBE
08".TUBERIA DW.SERIE 12.[6.100 ML].DESNUDO.PERFORADO SUBDREN	08120020
08".TUBERIA DW.SERIE 12.[6.100 ML].CAMPANA.PERFORADO MEDIA CANA SUBDREN	08120020IB
10".TUBERIA DW.SERIE 12.[6.100 ML].CAMPANA.PERFORADO.MEDIA CANA.SUBDREN	10120020IB

Serie 13

Descripción	Código
04" TUBERIA DW.SERIE 13. 6.09 M. CAMPANA.PERFORADO CANA COMPLETA. SUBDREN SN4	04130020IB4
06".TUBERIA DW.SERIE 13.[6.110 ML].CAMPANA.PERFORADO CANA COMPLETA. SUBDREN SN4	06130020IB4
08" TUBERIA DW.SERIE 13. 6.09 M. CAMPANA.PERFORADO CANA COMPLETA. SUBDREN SN4	08130020IB4
10" TUBERIA DW.SERIE 13. 6.09 M. CAMPANA.PERFORADO CANA COMPLETA. SUBDREN SN4	10130020IB4

Serie 71

Descripción	Código
12".TUBERIA DW.SERIE 71.[6.02 M].CAMPANA.PERFORADO CANA COMPLETA. SUBDREN SN4	12710020IB304
15".TUBERIA DW.SERIE 71.[6.16 M] CAMPANA.PERFORADO CANA COMPLETA. SUBDREN SN4.INCLUYE 1 EMPAQUE	15710020IB304
18".TUBERIA DW.SERIE 71.[6.02 M]. CAMPANA.PERFORADO CANA COMPLETA. SUBDREN SN4.INCLUYE 1 EMPAQUE	18710020IB304
24".TUBERIA DW.SERIE 71.[6.11 M].CAMPANA.PERFORADO CANA COMPLETA. SUBDREN SN4	24710020IB304

Serie 81

Descripción	Código
12".TUBERIA DW.SERIE 81.[6.050 ML].CAMPANA.PERFORADO SUBDREN	12810020IB30
15".TUBERIA DW.SERIE 81.[6.160 ML].CAMPANA.PERFORADO CANA COMPLETA.SUBDREN.INCLUYE 1 EMPAQUE	15810020IB30
18".TUBERIA DW.SERIE 81.[6.027 ML].CAMPANA.PERFORADO.CANA COMPLETA. SUBDREN.INCLUYE 1 EMPAQUE	18810020IB30
24".TUBERIA DW.SERIE 81.[6.180 ML].CAMPANA.PERFORADO.CANA COMPLETA. SUBDREN.INCLUYE 1 EMPAQUE	24810020IB30
30".TUBERIA DW.SERIE 81.[6.170 ML].CAMPANA.PERFORADO SUBDREN	30810020IB30
36".TUBERIA DW.SERIE 81.[6.000 ML].CONCAMPANA Y EMPAQUE.PERFORADO SUBDREN	36810020IB
42".TUBERIA N-12.SERIE 81.[6.020 ML].CAMPANA.PERFORADO SUBDREN	42810020IB
48".TUBERIA N-12.SERIE 81.[6.020 ML].CAMPANA.PERFORADO SUBDREN	48810020IB
60".TUBERIA N-12.SERIE 81.[6.020 ML].CAMPANA.PERFORADO SUBDREN	60810020IB

Serie 91

Descripción	Código
12".TUBERIA DW.SERIE 91.[5.861 ML].DESNUDO.PERFORADO SUBDREN	1291001930
15".TUBERIA DW.SERIE 91.[6.160 ML].DESNUDO.PERFORADO.CANA COMPLETA. SUBDREN	1591002030
18".TUBERIA DW.SERIE 91.[5.728 ML].DESNUDO.PERFORADO.CANA COMPLETA.SUBDREN	1891001930
24".TUBERIA DW.SERIE 91.[5.886 ML].DESNUDO.PERFORADO.CANA COMPLETA. SUBDREN	2491001930
30".TUBERIA DW.SERIE 91.[5.730 ML].DESNUDO.PERFORADO SUBDREN	3091001930
36".TUBERIA DW.SERIE 91.[5.790 ML].PERFORADO SUBDREN	36910019
42".TUBERIA DW.SERIE 91.[5.790 ML].PERFORADO SUBDREN	42910019
48".TUBERIA DW.SERIE 91.[5.790 ML].PERFORADO SUBDREN	48910019
60".TUBERIA DW.SERIE 91.[5.790 ML].PERFORADO SUBDREN	60910019

Serie 95

Descripción	Código
12".TUBERIA DW.SERIE 95.[5.790 ML].DESNUDO.SOLIDO	1295001930
15".TUBERIA DW.SERIE 95.[5.905 ML].DESNUDO.SOLIDO	1595001930
18".TUBERIA DW.SERIE 95.[5.728 ML].DESNUDO.SOLIDO	1895001930
24".TUBERIA DW.SERIE 95.[5.886 ML].DESNUDO.SOLIDO. SUBDREN	2495001930
30".TUBERIA DW.SERIE 95.[5.730 ML].DESNUDO.SOLIDO	3095001930
36".TUBERIA N-12.SERIE 95.[5.790 ML].DESNUDO.SOLIDO	36950019
42".TUBERIA DW.SERIE 95.[5.580 ML].DESNUDO.SOLIDO	42950019
48".TUBERIA N-12.SERIE 95.[5.790 ML].DESNUDO.SOLIDO	48950019
60".TUBERIA N-12.SERIE 95.[5.790 ML].DESNUDO.SOLIDO	60950019

Serie 23

Descripción	Código
04".TUBERIA DW.SERIE 23.[6.130 ML].DESNUDO.CALCETIN SUBDREN	04230020
04".TUBERIA DW.SERIE 23.[6.130 ML].CAMPANA.CALCETIN SUBDREN	04230020IB
06".TUBERIA DW.SERIE 23.[6.110 ML].DESNUDO.CALCETIN SUBDREN	06230020
06".TUBERIA DW.SERIE 23.[6.110 ML].CAMPANA.CALCETIN SUBDREN	06230020IB
08".TUBERIA DW.SERIE 23.[6.100 ML].DESNUDO.CALCETIN SUBDREN	08230020
08".TUBERIA DW.SERIE 23.[6.100 ML].CAMPANA.CALCETIN SUBDREN	08230020IB
10".TUBERIA DW.SERIE 23.[6.100 ML].CAMPANA.CALCETIN SUBDREN	10230020IB

Serie 86

Descripción	Código
12".TUBERIA DW.SERIE 30.[6.090 ML].CAMPANA.PERFORADO AASHTO FILTRO	12830020IB30
15".TUBERIA DW.SERIE 83.[6.150 ML].CAMPANA.PERFORADO CANA COMPLETA.CALCETIN SUBDREN	15830020IB30
18".TUBERIA DW.SERIE 83.[6.027 ML].CAMPANA.PERFORADO CANA COMPLETA.CALCETIN SUBDREN	18830020IB30
24".TUBERIA DW.SERIE 83.[6.130 ML].CAMPANA.PERFORADO CANA COMPLETA.CALCETIN SUBDREN	24830020IB30
30".TUBERIA DW.SERIE 83.[6.170 ML].CAMPANA.PERFORADO CANA COMPLETA.CALCETIN SUBDREN. INCLUYE 1 EMPAQUE	30830020IB30
36".TUBERIA DW.SERIE 30.[6.010 ML].CAMPANA.PERFORADO AASHTO FILTRO	36830020IB
42".TUBERIA DW.SERIE 30.[6.050 ML].CAMPANA.PERFORADO AASHTO FILTRO	42830020IB

LowHead (baja presión)

Tubería para drenaje a baja presión

Serie 60

Descripción	Código
24. TUBERIA DW.SERIE 24.[6.030 ML].LOW HEAD - NMXE241	24600020IB301005
30. TUBERIA DW.SERIE 30.[6.030 ML].LOW HEAD - NMXE241	30600020IB301005
36. TUBERIA DW.SERIE 36.[6.030 ML].LOW HEAD - NMXE241	36600020IB1005
42. TUBERIA DW.SERIE 42.[6.030 ML].LOW HEAD - NMXE241	42600020IB1005
48. TUBERIA DW.SERIE 48.[6.030 ML].LOW HEAD - NMXE241	48600020IB1005
60. TUBERIA DW.SERIE 60.[6.030 ML].LOW HEAD - NMXE241	60600020IB1004

Tubería conduit ROJO

Diámetro (mm)	Longitud Mts	Unidad	Descripción	Código
38	50	Rollo	1.5".TUBERIA DW.SERIE 16 CONDUIT ROLLO FLEXIBLE	38160167UP
38	100	Rollo	1.5".TUBERIA DW.SERIE 16 CONDUIT ROLLO FLEXIBLE	38160335UP
50	100	Rollo	02".TUBERIA DW.SERIE 16 CONDUIT ROLLO FLEXIBLE	02160335UP
75	100	Rollo	03".TUBERIA DW.SERIE 16 CONDUIT ROLLO FLEXIBLE	03160335UP
100	100	Rollo	04".TUBERIA DW.SERIE 16 CONDUIT ROLLO FLEXIBLE	04160335UP



Tubería Conduit de TRANSICIÓN NEGRO

Diámetro (mm)	Longitud Mts	Unidad	Descripción	Código
75	6.15	Tmo	03".TUBERIA DW.SERIE 17 CAMPANA TRANSICION	03170020UP
100	6.13	Tmo	04".TUBERIA DW.SERIE 17 CAMPANA TRANSICION	04170020UP
150	6.10	Tmo	06".TUBERIA DW.SERIE 17 CAMPANA TRANSICION	06170020UP
200	6.10	Tmo	08".TUBERIA DW.SERIE 17 CAMPANA TRANSICION	08170020UP



Tubería conduit ROJO

Diámetro (mm)	Longitud Mts	Unidad	Descripción	Código
50	6.15	Tmo	02".TUBERIA DW.SERIE 68 CAMPANA CONDUIT	02680020UP
75	6.12	Tmo	03".TUBERIA DW.SERIE 68 CAMPANA CONDUIT	03680020UP
100	6.13	Tmo	04".TUBERIA DW.SERIE 68 CAMPANA CONDUIT	04680020UP
150	6.11	Tmo	06".TUBERIA DW.SERIE 68 CAMPANA CONDUIT	06680020UP
200	6.10	Tmo	08".TUBERIA DW.SERIE 68 CAMPANA CONDUIT	08680020UP
250	6.10	Tmo	10".TUBERIA DW.SERIE 68 CAMPANA CONDUIT	10680020UP
300	6.05	Tmo	12".TUBERIA DW.SERIE 68 CAMPANA CONDUIT	12680020UP



Tubería TELECOM - AZUL

Diámetro (mm)	Longitud Mts	Unidad	Descripción	Código
38	100	Rollo	1.5".TUBERIA DW.SERIE 16. ROLLO FLEXIUM AZUL	38160335PEA
50	100	Rollo	02".TUBERIA DW.SERIE 16. ROLLO FLEXIUM AZUL	02160335PEA
75	100	Rollo	03".TUBERIA DW.SERIE 16. ROLLO FLEXIUM AZUL	03160335PEA
100	100	Rollo	04".TUBERIA DW.SERIE 16. ROLLO FLEXIUM AZUL	04160335PEA



Coples Inyectados

Diámetro (mm)	Unidad	Descripción	Código
38	Pza.	1.5".COPLER CAMPANA-CAMPANA INCLUYE DOS EMPAQUES	3813WTUP
50	Pza.	02".COPLER INYECTADO NEGRO	0213WTUP
75	Pza.	03".COPLER CAMPANA-CAMPANA	0313WTUP
100	Pza.	04".COPLER CAMPANA-CAMPANA	0413WTUP
150	Pza.	06" X 06".COPLER.HERMETICO.INYECTADO CAMPANA-CAMPANA	0613WTZ
200	Pza.	08" X 08".COPLER.HERMETICO.INYECTADO CAMPANA-CAMPANA	0813WTZ



Tapón Boquilla

Diámetro (mm)	Unidad	Descripción	Código
50	Pza.	02".TAPON BOQUILLA	0232AM
75	Pza.	03" TAPON BOQUILLA	0332AM
100	Pza.	04" TAPON BOQUILLA	0432AM



Separador de 1 vía

Diámetro (mm)	Unidad	Descripción	Código
50	Pza.	SEPARADOR DE 2" PARA 1 VÍA	02W201
75	Pza.	SEPARADOR DE 3" PARA 1 VÍA	03W201
100	Pza.	SEPARADOR DE 4" PARA 1 VÍA	04W201



Empaque Elastomérico

Diámetro (mm)	Unidad	Descripción	Código
38	Pza.	1.5".EMPAQUE.ELASTOMERICO	3859AG
50	Pza.	02".EMPAQUE.ELASTOMERICO	0259AG
75	Pza.	03".EMPAQUE.ELASTOMERICO	0359AG
100	Pza.	04".EMPAQUE.ELASTOMERICO	0459AG
150	Pza.	06".EMPAQUE.ELASTOMERICO	0659AG
200	Pza.	08".EMPAQUE.ELASTOMERICO	0859AG
250	Pza.	08".EMPAQUE.ELASTOMERICO	1065MG



Lubricante

Diámetro (mm)	Unidad	Descripción	Código
-	Pza.	LUBRICANTE VEGETAL (4 KG / PARA 1,500 LBS)	0800LU

Tubería PVC Ligera

Diámetro (mm)	Unidad	Descripción	Código
13	Tmo	Tubería PVC conduit Deplayusa (1/2") Lig. c/c	TUBL-13
19	Tmo	Tubería PVC conduit Deplayusa (3/4") Lig. c/c	TUBL-19
25	Tmo	Tubería PVC conduit Deplayusa (1") Lig. c/c	TUBL-25
32	Tmo	Tubería PVC conduit Deplayusa (1 1/4") Lig.c/c	TUBL-32
38	Tmo	Tubería PVC conduit Deplayusa (1 1/2") Lig. c/c	TUBL-38
50	Tmo	Tubería PVC conduit Deplayusa (2") Lig. c/c	TUBL-50

* Tramos de 3 mts con campana



Tubería PVC Pesada

Diámetro (mm)	Unidad	Descripción	Código
13	Tmo	Tubería PVC conduit Deplayusa (1/2") Pes. c/c	TUBP-13
19	Tmo	Tubería PVC conduit Deplayusa (3/4") Pes. c/c	TUBP-19
25	Tmo	Tubería PVC conduit Deplayusa (1") Pes. c/c	TUBP-25
32	Tmo	Tubería PVC conduit Deplayusa (1 1/4") Pes.c/c	TUBP-32
38	Tmo	Tubería PVC conduit Deplayusa (1 1/2") Pes. c/c	TUBP-38
50	Tmo	Tubería PVC conduit Deplayusa (2") Pes. c/c	TUBP-50
64	Tmo	Tubería PVC conduit Deplayusa (2 1/2") Pes. c/c	TUBP-64
75	Tmo	Tubería PVC conduit Deplayusa (3") Pes. c/c	TUBP-75
100	Tmo	Tubería PVC conduit Deplayusa (4") Pes. c/c	TUBP-100

* Tramos de 3 mts con campana

Curvas PVC Ligeras

Diámetro (mm)	Unidad	Descripción	Código
13	Pza	Codo 90° Deplayusa (1/2") Lig.	CURL-13
19	Pza	Codo 90° Deplayusa (3/4") Lig.	CURL-19
25	Pza	Codo 90° Deplayusa (1") Lig.	CURL-25
32	Pza	Codo 90° Deplayusa (1 1/4") Lig.	CURL-32
38	Pza	Codo 90° Deplayusa (1 1/2") Lig.	CURL-38
50	Pza	Codo 90° Deplayusa (2") Lig.	CURL-50



Curvas PVC Pesada

Diámetro (mm)	Unidad	Descripción	Código
13	Pza	Codo 90° Deplayusa (1/2") Pesado	CURP-13
19	Pza	Codo 90° Deplayusa (3/4") Pesado	CURP-19
25	Pza	Codo 90° Deplayusa (1") Pesado	CURP-25
32	Pza	Codo 90° Deplayusa (1 1/4") Pesado	CURP-32
38	Pza	Codo 90° Deplayusa (1 1/2") Pesado	CURP-38
50	Pza	Codo 90° Deplayusa (2") Pesado	CURP-50
64	Pza	Codo 90° Deplayusa (2 1/2") Pesado	CURP-64
75	Pza	Codo 90° Deplayusa (3") Pesado	CURP-75
100	Pza	Codo 90° Deplayusa (4") Pesado	CURP-100

Conectores PVC ligeros

Diámetro (mm)	Unidad	Descripción	Código
13	Pza	Conector Deplayusa (1/2") Ligero c/tuerca	CONLT13
19	Pza	Conector Deplayusa (3/4") Ligero c/tuerca	CONLT19
25	Pza	Conector Deplayusa (1") Ligero c/tuerca	CONLT25
32	Pza	Conector Deplayusa (1 1/4") Ligero c/tuerca	CONLT32
38	Pza	Conector Deplayusa (1 1/2") Ligero c/tuerca	CONLT38
50	Pza	Conector Deplayusa (2") Ligero c/tuerca	CONLT50

Conectores PVC Pesados

Diámetro (mm)	Unidad	Descripción	Código
13	Pza	Conector Deplayusa (1/2") Pesado c/tuerca	CONPT13
19	Pza	Conector Deplayusa (3/4") Pesado c/tuerca	CONPT19
25	Pza	Conector Deplayusa (1") Pesado c/tuerca	CONPT25
32	Pza	Conector Deplayusa (1 1/4") Pesado c/tuerca	CONPT32
38	Pza	Conector Deplayusa (1 1/2") Pesado c/tuerca	CONPT38
50	Pza	Conector Deplayusa (2") Pesado c/tuerca	CONPT50
64	Pza	Conector Deplayusa (2 1/2") Pesado c/tuerca	CONPT64
75	Pza	Conector Deplayusa (3") Pesado c/tuerca	CONPT75
100	Pza	Conector Deplayusa (4") Pesado c/tuerca	CONPT100

Coples PVC Pesados

Diámetro (mm)	Unidad	Descripción	Código
13	Pza	Codo 90° Deplayusa (1/2") Pesado	CURP-13
19	Pza	Codo 90° Deplayusa (3/4") Pesado	CURP-19
25	Pza	Codo 90° Deplayusa (1") Pesado	CURP-25
32	Pza	Codo 90° Deplayusa (1 1/4") Pesado	CURP-32
38	Pza	Codo 90° Deplayusa (1 1/2") Pesado	CURP-38
50	Pza	Codo 90° Deplayusa (2") Pesado	CURP-50
64	Pza	Codo 90° Deplayusa (2 1/2") Pesado	CURP-64
75	Pza	Codo 90° Deplayusa (3") Pesado	CURP-75
100	Pza	Codo 90° Deplayusa (4") Pesado	CURP-100



Chalupas

Diámetro (mm)	Unidad	Descripción	Código
19	Pza	Chalupa Deplayusa 4 x 2 reforzada verde.	04CHAPEVE
19	Pza	Chalupa Deplayusa 4 x 2 reforzada gris plata	04CHAPPGR



Cajas de registro

Diámetro (mm)	Unidad	Descripción	Código
13	Pza	Registro c/ tapa 3x3" reforzado verde.	03RCTPEVE
19	Pza	Registro c/ tapa 4x4" reforzado verde.	04RCTPEVE
25	Pza	Registro c/ tapa 5x5" reforzado verde.	05RCTPEVE



Sobretapa

Diámetro (mm)	Unidad	Descripción	Código
19	Pza	Sobretapa con salida rectangular "4x2"	04CNTPPVE



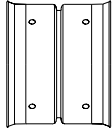

Cople externo a presión (SNAP)

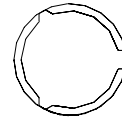

Cople abierto

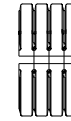

4" - 24" COPLE EXTERNO A PRESIÓN (SNAP)

Diámetros	Código
4" (100mm)	0412AAZ
6" (150mm)	0613AAZ
8" (200mm)	0813AAZ
10" (250mm)	1013AAZ
12" (300mm)	1214AAZ
15" (375mm)	1514AAZ
18" (450mm)	1814AAZ
24" (600mm)	2414AAZ

10" - 60" COPLE ABIERTO

Diámetros	Código	
	Solo el cople	Cople con empaque
10" (250mm)	1011AAZ	1066AAZ
12" (300mm)	1265AAZ	1266AAZ
15" (375mm)	1565AAZ	1566AAZ
18" (450mm)	1865AAZ	1866AAZ
24" (600mm)	¹ 2463AAZ	2412AAZ
30" (750mm)	² 3063AAZ	3066AAZ
36" (900mm)	3661AAZ	3662AAZ
42" (1050mm)	4265AAZ	4266AAZ
48" (1200mm)	4865AAZ	4866AAZ
60" (1500mm)	6065AAZ	6066AAZ

10" - 36" COPLE ABIERTO DE DOBLE ANCHO

Diámetros	Código
10" (250mm)	1069AAZ
12" (300mm)	1269AAZ
15" (375mm)	1569AAZ
18" (450mm)	1869AAZ
24" (600mm)	2469AAZ
30" (750mm)	3069AAZ
36" (900mm)	3669AC



Cople abierto de doble ancho

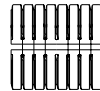

12" - 60" COPLE CAMPANA-CAMPANA

Diámetros	Cople campana - campana incluye 2 empaques	
	Código	
12" (300mm)	1215AAZ	
15" (375mm)	1515AAZ	
18" (450mm)	1815AAZ	
24" (600mm)	^{1,3} 2413AAZ	
30" (750mm)	^{2,4} 3013AN65	
36" (900mm)	3613AN65	
42" (1050mm)	4213AN65	
48" (1200mm)	4813AN65	
60" (1500mm)	6013AN65	

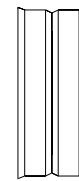

Cople campana - campana

12" - 60" COPLE CAMPANA-CAMPANA DESALINEADO

Diámetros	Ángulo	Código	Ángulo	Código
12" (300mm)	3°	1213ANMC03	5°	1213ANMC05
15" (375mm)	3°	1513ANMC03	5°	1513ANMC05
18" (450mm)	3°	1813ANMC03	5°	1813ANMC05
24" (600mm)	3°	2413ANMC03	5°	2413ANMC05
30" (750mm)	3°	3013ANMC03	5°	3013ANMC05
36" (900mm)	3°	3613ANMC03	5°	3613ANMC05
42" (1050mm)	3°	4213ANMC03	5°	4213ANMC05
48" (1200mm)	3°	4813ANMC03	5°	4813ANMC05
60" (1500mm)	3°	6013ANMC03	5°	6013ANMC05

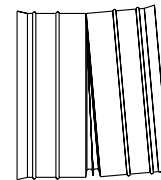

Cople campana-campana desalineado

¹ Código compatible con tubería 24" IB30.

² Código compatible con tubería 30" IB30.

³ Para este código los empaques no están incluidos, se requieren DOS (2) empaques 2459AGZ y DOS (2) empaques 2466MGT.

⁴ Para este código se incluyen empaques 3059AGZ y campanas compatibles con perfil de tubería.

⁵ Tubería de Serie 30 y 33 es compatible con los accesorios que ofrece este catálogo.

JUNTA CON SELLO INTERNO (NPC)

Diámetros	Ancho	Código
18" (450mm)	7.5" (190mm)	1891NS
	10.5" (266mm)	1892NS
24" (600mm)	7.5" (190mm)	2491NS
	10.5" (266mm)	2492NS
30" (750mm)	7.5" (190mm)	3091NS
	10.5" (266mm)	3092NS
36" (900mm)	7.5" (190mm)	3691NS
	10.5" (266mm)	3692NS
42" (1050mm)	7.5" (190mm)	4291NS
	10.5" (266mm)	4292NS
48" (1200mm)	7.5" (190mm)	4891NS
	10.5" (266mm)	4892NS
60" (1500mm)	7.5" (190mm)	6091NS
	10.5" (266mm)	6092NS



Cople de reparación en campo ancho sencillo

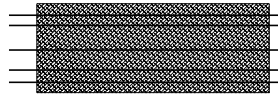

Cople de reparación en campo ancho doble

COPLE DE REPARACIÓN EN CAMPO - ANCHO SENCILLO (MAR-MAC®)

Diámetros	Código
8" (200mm)	0867RC
10" (250mm)	1067RC
12" (300mm)	1267RC
15" (375mm)	1567RC
18" (450mm)	1867RC
24" (600mm)	2467RC
30" (750mm)	3067RC
36" (900mm)	3667RC
42" (1050mm)	4267RC
48" (1200mm)	4867RC
54" (1350mm)	5467RC
60" (1500mm)	6067RC

COPLE DE REPARACIÓN EN CAMPO - ANCHO DOBLE (MAR-MAC®)

Diámetros	Código
12" (300mm)	1267RCD
15" (375mm)	1567RCD
18" (450mm)	1867RCD
24" (600mm)	2467RCD
30" (750mm)	3067RCD
36" (900mm)	3667RCD
42" (1050mm)	4267RCD
48" (1200mm)	4867RCD
54" (1350mm)	5467RCD
60" (1500mm)	6067RCD

LUBRICANTE PARA JUNTAS		
Diámetros	1/4 galón (0.9 L)	1 galón (3.8 L)
	Código	Código
	0800L	0800LU
	Rendimiento de uniones por cubeta	Rendimiento de uniones por cubeta
4" (100mm)	89	356
6" (150mm)	61	244
8" (200mm)	43	172
10" (250mm)	33	132
12" (300mm)	25	100
15" (375mm)	20	80
18" (450mm)	16	64
24" (600mm)	10	40
30" (750mm)	9	36
36" (900mm)	7	28
42" (1050mm)	6	24
48" (1200mm)	6	24
48" (1200mm)	5	20
60" (1500mm)	5	20

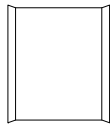

Cople deslizable de reparación (PVC)

COPEL DESLIZABLE DE REPARACIÓN (PVC)	
Diámetros	Código
10" (250mm)	1075AGZ
12" (300mm)	1275AGZ
15" (375mm)	1575AGZ
18" (450mm)	1875AGZ
24" (600mm)	2475AG

Típicamente se necesitan: dos coples de reparación, cuatro empaques, lubricante y un tramo de tubo para la reparación.

NOTA: Póngase en contacto con su representante de ventas local para la reparación en campo de tubería de diámetro de 30" a 60" (900 a 1500 mm) para revisar la disponibilidad de coples no listados.

Tapas para inicio de redes y adaptadores

Accesorios para tubo de pared doble

12" - 60" TAPAS*

Diámetros	Tapa de espiga	Tapa de campana incluye 1 empaque
	Código	Código
12" (300mm)	1201AN	1201AN65B
15" (375mm)	1501AN	1501AN65B
18" (450mm)	1801AN	1801AN65B
24" (600mm)	2401AN	2401AN65B
30" (750mm)	3001AN	3001AN65B
36" (900mm)	3601AN	3601AN65B
42" (1050mm)	4201AN	4201AN65B
48" (1200mm)	4801AN	4801AN65B
60" (1500mm)	6001AN	6001AN65B



Tapa de espiga

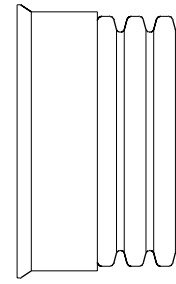

Tapa de campana

-Las tapas son solo para aplicaciones horizontales para el inicio de una red de atarjeas o colectores. No se permite que las tapas se utilicen en ninguna aplicación vertical. El mal uso o el mal aseguramiento en la colocación de las tapas puede resultar en daños a personas o propiedades o puede resultar en lesiones o la muerte.

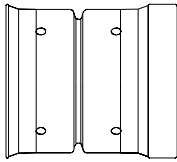

Cople externo a presión con tapa
(la tapa se puede cortar para continuar la red de drenaje en un futuro)

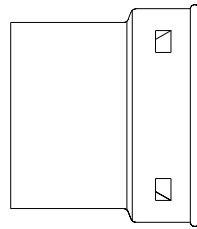

Adaptador para drenaje pluvial

6" - 10" COPLE EXTERNO A PRESIÓN CON TAPA

Diámetros	Código
6" (150mm)	0667AAZ
8" (200mm)	0867AAZ
10" (250mm)	1067AAZ

ADAPTADOR PARA DRENAJE PLUVIAL

Diámetro	Código
4" (100mm)	0467AAZ

8" - 60" TAPA CON EMPAQUE PARA TUBERÍA SIN PRESIÓN

Diámetros	Código
8" (200mm)	0833AAZ
10" (250mm)	1033AAZ
12" (300mm)	1233AAZ
15" (375mm)	1533AAZ
18" (450mm)	1833AAZ
24" (600mm)	2433AAZ
30" (750mm)	3033AAZ
36" (900mm)	3633AAZ
42" (1050mm)	4233AAZ
48" (1200mm)	4833AAZ
60" (1500mm)	6033AAZ

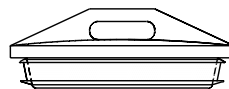
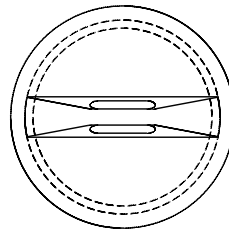

Tapa con empaque para tubería sin presión

- Se recomienda su uso para restringir el acceso a tubería conectada en pozo de visita en proceso de instalación.
- No disponible para uso permanente ni orientación vertical.

Tapas para inicio de redes y adaptadores

Accesorios para tubo de pared doble

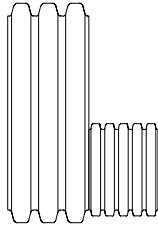

Reductor espiga- espiga

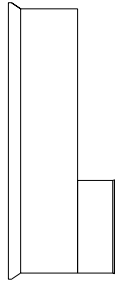

Reductor campana - campana

6" - 30" REDUCTORES FABRICADOS

Diámetros	espiga-espiga	campana-campana incluye 2 empaques
	Código	Código
6"x4" (150mm x 100mm)	0670AN	
8"x4" (200mm x 100mm)	0870AN	
8"x6" (200mm x 150mm)	0871AN	
10"x4" (250mm x 100mm)	1070AN	
10"x6" (250mm x 150mm)	1071AN	
10"x8" (250mm x 200mm)	1072AN	
12"x4" (300mm x 100mm)	1270AN	1270AN65B
12"x6" (300mm x 150mm)	1271AN	1271AN65B
12"x8" (300mm x 200mm)	1272AN	1272AN65B
12"x10" (300mm x 250mm)	1273AN	1273AN65B
15"x4" (375mm x 100mm)	1570AN	1570AN65B
15"x6" (375mm x 150mm)	1571AN	1571AN65B
15"x8" (375mm x 200mm)	1572AN	1572AN65B
15"x10" (375mm x 250mm)	1573AN	1573AN65B
15"x12" (375mm x 300mm)	1574AN	1574AN65B
18"x4" (450mm x 100mm)	1870AN	1870AN65B
18"x6" (450mm x 150mm)	1871AN	1871AN65B
18"x8" (450mm x 200mm)	1872AN	1872AN65B
18"x10" (450mm x 250mm)	1873AN	1873AN65B
18"x12" (450mm x 300mm)	1874AN	1874AN65B
18"x15" (450mm x 375mm)	1875AN	1875AN65B
24"x4" (600mm x 100mm)	2470AN	2470AN65B
24"x6" (600mm x 150mm)	2471AN	2471AN65B
24"x8" (600mm x 200mm)	2472AN	2472AN65B
24"x10" (600mm x 250mm)	2473AN	2473AN65B
24"x12" (600mm x 300mm)	2474AN	2474AN65B
24"x15" (600mm x 375mm)	2475AN	2475AN65B
24"x18" (600mm x 450mm)	2476AN	2476AN65B
30"x4" (750mm x 100mm)	3070AN	3070AN65B
30"x6" (750mm x 150mm)	3071AN	3071AN65B
30"x8" (750mm x 200mm)	3072AN	3072AN65B
30"x10" (750mm x 250mm)	3073AN	3073AN65B
30"x12" (750mm x 300mm)	3074AN	3074AN65B
30"x15" (750mm x 375mm)	3075AN	3075AN65B
30"x18" (750mm x 450mm)	3076AN	3076AN65B
30"x24" (750mm x 600mm)	3077AN	3077AN65B

-Reductores estándar son excentricos. Hay disponibles reductores concéntricos, solicítelos a su representante de ventas.

REDUCTORES FABRICADOS

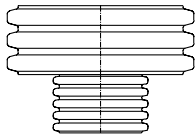

Vista superior

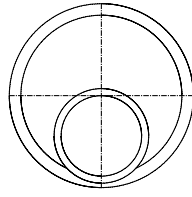

Vista frontal

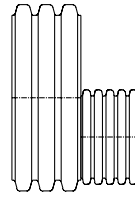

Vista lateral

36" - 60" REDUCTORES FABRICADOS

Diámetros	Reductor espiga	campana-campana incluye 2 empaques
	Código	Código
36"x4" (900mm x 100mm)	3670AN	3670AN65B
36"x6" (900mm x 150mm)	3671AN	3671AN65B
36"x8" (900mm x 200mm)	3672AN	3672AN65B
36"x10" (900mm x 250mm)	3673AN	3673AN65B
36"x12" (900mm x 300mm)	3674AN	3674AN65B
36"x15" (900mm x 375mm)	3675AN	3675AN65B
36"x18" (900mm x 450mm)	3676AN	3676AN65B
36"x24" (900mm x 600mm)	3677AN	3677AN65B
36"x30" (900mm x 750mm)	3678AN	3678AN65B
42"x6" (1050mm x 150mm)	4271AN	4271AN65B
42"x8" (1050mm x 200mm)	4272AN	4272AN65B
42"x10" (1050mm x 250mm)	4273AN	4273AN65B
42"x12" (1050mm x 300mm)	4274AN	4274AN65B
42"x15" (1050mm x 375mm)	4275AN	4275AN65B
42"x18" (1050mm x 450mm)	4276AN	4276AN65B
42"x24" (1050mm x 600mm)	4277AN	4277AN65B
42"x30" (1050mm x 750mm)	4278AN	4278AN65B
42"x36" (1050mm x 900mm)	4279AN	4279AN65B
48"x12" (1200mm x 300mm)	4874AN	4874AN65B
48"x15" (1200mm x 375mm)	4875AN	4875AN65B
48"x18" (1200mm x 450mm)	4876AN	4876AN65B
48"x24" (1200mm x 600mm)	4877AN	4877AN65B
48"x30" (1200mm x 750mm)	4878AN	4878AN65B
48"x36" (1200mm x 900mm)	4879AN	4879AN65B
48"x42" (1200mm x 1050mm)	4842AN	4842AN65B
60"x24" (1500mm x 600mm)	6077AN	6077AN65B
60"x30" (1500mm x 750mm)	6078AN	6078AN65B
60"x36" (1500mm x 900mm)	6079AN	6079AN65B
60"x42" (1500mm x 1050mm)	6042AN	6042AN65B
60"x48" (1500mm x 1200mm)	6048AN	6048AN65B

-Reductores estándar son excentricos. Hay disponibles reductores concéntricos, solicítelos a su representante de ventas.

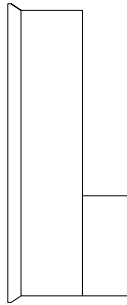

Cople reductor

TAPA REDUCTORA

Diámetros	N-12 WT Includes 1 gasket
	Código
6"x4"(150mm x 100mm)	0670AN65BS
8"x4"(200mm x 100mm)	0870AN65BS
8"x6"(200mm x 150mm)	0871AN65BS
10"x4"(250mm x 100mm)	1070AN65BS
10"x6"(250mm x 150mm)	1071AN65BS
10"x8"(250mm x 200mm)	1072AN65BS
12"x4"(300mm x 100mm)	1270AN65BS
12"x6"(300mm x 150mm)	1271AN65BS
12"x8"(300mm x 200mm)	1272AN65BS
15"x4"(375mm x 100mm)	1570AN65BS
15"x6"(375mm x 150mm)	1571AN65BS
15"x8"(375mm x 200mm)	1572AN65BS
18"x4"(450mm x 100mm)	1870AN65BS
18"x6"(450mm x 150mm)	1871AN65BS
18"x8"(450mm x 200mm)	1872AN65BS
24"x4"(600mm x 100mm)	2470AN65BS
24"x6"(600mm x 150mm)	2471AN65BS
24"x8"(600mm x 200mm)	2472AN65BS
30"x4"(750mm x 100mm)	3070AN65BS
30"x6"(750mm x 150mm)	3071AN65BS
30"x8"(750mm x 200mm)	3072AN65BS
36"x4"(750mm x 100mm)	3670AN65BS
36"x6"(750mm x 150mm)	3671AN65BS
36"x8"(750mm x 200mm)	3672AN65BS

-Reductores estándar son excentricos. Hay disponibles reductores concentricos, solicítelos a su representante de ventas.

4" - 60" CODO FABRICADO A 11.25°

Diámetros	espiga - espiga	campana-campana incluye 2 empaques
	Código	Código
4" (100mm)	0491AN	
6" (150mm)	0691AN	
8" (200mm)	0891AN	
10" (250mm)	1091AN	
12" (300mm)	1291AN	1291AN65B
15" (375mm)	1591AN	1591AN65B
18" (450mm)	1891AN	1891AN65B
24" (600mm)	2491AN	2491AN65B
30" (750mm)	3091AN	3091AN65B
36" (900mm)	3691AN	3691AN65B
42" (1050mm)	4291AN	4291AN65B
48" (1200mm)	4891AN	4891AN65B
60" (1500mm)	6091AN	6091AN65B

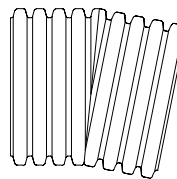

Codo espiga - espiga a 11.25°

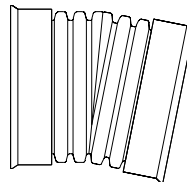

Codo campana - campana a 11.25°

4" - 60" CODO FABRICADO A 22.5°

Diámetros	espiga - espiga	Campana-campana incluye 2 empaques
	Código	Código
4" (100mm)	0492AN	
6" (150mm)	0692AN	
8" (200mm)	0892AN	
10" (250mm)	1092AN	
12" (300mm)	1292AN	1292AN65B
15" (375mm)	1592AN	1592AN65B
18" (450mm)	1892AN	1892AN65B
24" (600mm)	2492AN	2492AN65B
30" (750mm)	3092AN	3092AN65B
36" (900mm)	3692AN	3692AN65B
42" (1050mm)	4292AN	4292AN65B
48" (1200mm)	4892AN	4892AN65B
60" (1500mm)	6092AN	6092AN65B

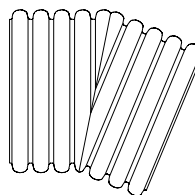

Codo espiga - espiga a 22.5°

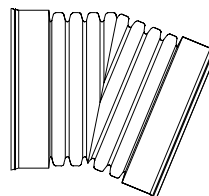

Codo campana - campana a 22.5°

4" - 60" CODO FABRICADO A 30°

Diámetros	espiga - espiga	campana-campana incluye 2 empaques
	Código	Código
4" (100mm)	0495AN	
6" (150mm)	0695AN	
8" (200mm)	0895AN	
10" (250mm)	1095AN	
12" (300mm)	1295AN	1295AN65B
15" (375mm)	1595AN	1595AN65B
18" (450mm)	1895AN	1895AN65B
24" (600mm)	2495AN	2495AN65B
30" (750mm)	3095AN	3095AN65B
36" (900mm)	3695AN	3695AN65B
42" (1050mm)	4295AN	4295AN65B
48" (1200mm)	4895AN	4895AN65B
60" (1500mm)	6095AN	6095AN65B

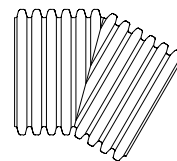

Codo espiga - espiga a 30°

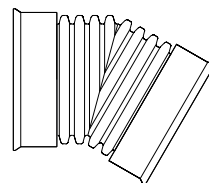

Codo campana - campana a 30°

-Reductores estándar son excentricos. Hay disponibles reductores concentricos, solicítelos a su representante de ventas.

12" - 60" CODO FABRICADO A 60°

Diámetros	espiga - espiga	
	Código	Código
12" (300mm)	1297AN	1297AN65BB
15" (375mm)	1597AN	1597AN65BB
18" (450mm)	1897AN	1897AN65BB
24" (600mm)	2497AN	2497AN65BB
30" (750mm)	3097AN	3097AN65BB
36" (900mm)	3697AN	3697AN65BB
42" (1050mm)	4297AN	4297AN65BB
48" (1200mm)	4897AN	4897AN65BB
60" (1500mm)	6097AN	6097AN65BB

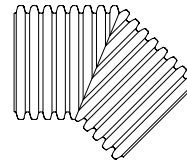

Codo espiga - espiga a 45°

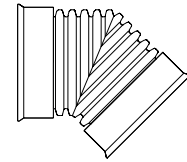

Codo campana - campana a 45°

12" - 60" CODO FABRICADO A 45°

Diámetros	espiga - espiga	
	Código	Código
12" (300mm)	1294AN	1294AN65B
15" (375mm)	1594AN	1594AN65B
18" (450mm)	1894AN	1894AN65B
24" (600mm)	2494AN	2494AN65B
30" (750mm)	3094AN	3094AN65B
36" (900mm)	3694AN	3694AN65B
42" (1050mm)	4294AN	4294AN65B
48" (1200mm)	4894AN	4894AN65B
60" (1500mm)	6094AN	6094AN65B

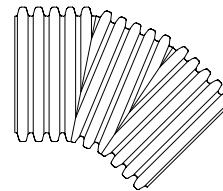

Codo de desarrollo largo espiga - espiga a 45°

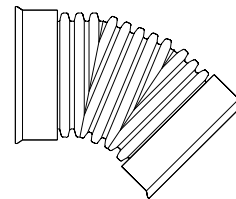

Codo de desarrollo largo campana - campana a 45°

12" - 18" CODO FABRICADO A 90°

Diámetros	espiga - espiga	
	Código	Código
12" (300mm)	1299AN	1299AN65B
15" (375mm)	1599AN	1599AN65B
18" (450mm)	1899AN	1899AN65B

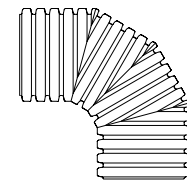

Codo de desarrollo largo espiga - espiga a 90°

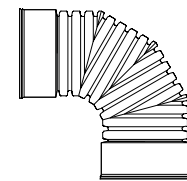

Codo de desarrollo largo campana - campana a 90°

-Reductores estándar son excentricos. Hay disponibles reductores concentricos, solicítelos a su representante de ventas.

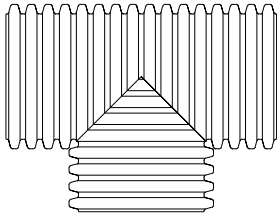

TEE espiga - espiga

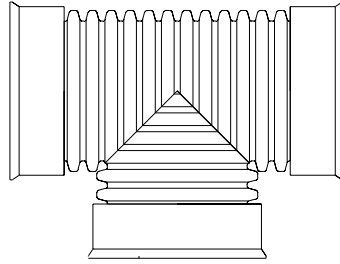

TEE campana - campana

12" - 60" TEE FABRICADO

Diámetros	espiga - espiga	campana-campana incluye 3 empaques
	Código	Código
12" (300mm)	1264AN	1264AN65B
15" (375mm)	1565AN	1565AN65B
18" (450mm)	1866AN	1866AN65B
24" (600mm)	2467AN	2467AN65B
30" (750mm)	3068AN	3068AN65B
36" (900mm)	3669AN	3669AN65B
42" (1050mm)	4251AN	4251AN65BB
48" (1200mm)	4851AN	4851AN65BB
60" (1500mm)	6051AN	6051AN65BB

10" - 36" TEE REDUCTOR FABRICADO

Diámetros	espiga - espiga	campana-campana incluye 3 empaques	campana-campana incluye 3 empaques
	Código	Código	Código
10"x4"(250mm x 100mm)	1060AN		
10"x6"(250mm x 150mm)	1061AN		
10"x8"(250mm x 200mm)	1062AN		
12"x4"(300mm x 100mm)	1260AN	1260AN85B	1260AN65B
12"x6"(300mm x 150mm)	1261AN	1261AN85B	1261AN65B
12"x8"(300mm x 200mm)	1262AN	1262AN85B	1262AN65B
12"x10"(300mm x 250mm)	1263AN	1263AN85B	1263AN65B
15"x4"(375mm x 100mm)	1560AN	1560AN85B	1560AN65B
15"x6"(375mm x 150mm)	1561AN	1561AN85B	1561AN65B
15"x8"(375mm x 200mm)	1562AN	1562AN85B	1562AN65B
15"x10"(375mm x 250mm)	1563AN	1563AN85B	1563AN65B
15"x12"(375mm x 300mm)	1564AN	1564AN85B	1564AN65B
18"x4"(450mm x 100mm)	1860AN	1860AN85B	1860AN65B
18"x6"(450mm x 150mm)	1861AN	1861AN85B	1861AN65B
18"x8"(450mm x 200mm)	1862AN	1862AN85B	1862AN65B
18"x10"(450mm x 250mm)	1863AN	1863AN85B	1863AN65B
18"x12"(450mm x 300mm)	1864AN	1864AN85B	1864AN65B
18"x15"(450mm x 375mm)	1865AN	1865AN85B	1865AN65B
24"x4"(600mm x 100mm)	2460AN	2460AN85B	2460AN65B
24"x6"(600mm x 150mm)	2461AN	2461AN85B	2461AN65B
24"x8"(600mm x 200mm)	2462AN	2462AN85B	2462AN65B
24"x10"(600mm x 250mm)	2463AN	2463AN85B	2463AN65B
24"x12"(600mm x 300mm)	2464AN	2464AN85B	2464AN65B
24"x15"(600mm x 375mm)	2465AN	2465AN85B	2465AN65B
24"x18"(600mm x 450mm)	2466AN	2466AN85B	2466AN65B
30"x4"(750mm x 100mm)	3060AN	3060AN85B	3060AN65B
30"x6"(750mm x 150mm)	3061AN	3061AN85B	3061AN65B
30"x8"(750mm x 200mm)	3062AN	3062AN85B	3062AN65B
30"x10"(750mm x 250mm)	3063AN	3063AN85B	3063AN65B
30"x12"(750mm x 300mm)	3064AN	3064AN85B	3064AN65B
30"x15"(750mm x 375mm)	3065AN	3065AN85B	3065AN65B
30"x18"(750mm x 450mm)	3066AN	3066AN85B	3066AN65B
30"x24"(750mm x 600mm)	3067AN	3067AN85B	3067AN65B
36"x4"(900mm x 100mm)	3660AN	3660AN85B	3660AN65B
36"x6"(900mm x 150mm)	3661AN	3661AN85B	3661AN65B
36"x8"(900mm x 200mm)	3662AN	3662AN85B	3662AN65B
36"x10"(900mm x 250mm)	3663AN	3663AN85B	3663AN65B
36"x12"(900mm x 300mm)	3664AN	3664AN85B	3664AN65B
36"x15"(900mm x 375mm)	3665AN	3665AN85B	3665AN65B
36"x18"(900mm x 450mm)	3666AN	3666AN85B	3666AN65B
36"x24"(900mm x 600mm)	3667AN	3667AN85B	3667AN65B
36"x30"(900mm x 750mm)	3668AN	3668AN85B	3668AN65B

Vista frontal

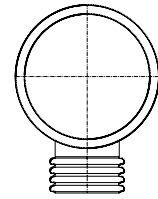

Vista superior

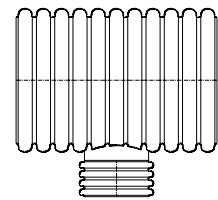

TEE reductor
espiga - espiga

Vista superior

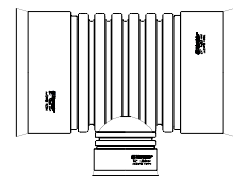

TEE reductor
campana - campana

42" - 60" TEE REDUCTOR FABRICADO

Diámetros	espiga - espiga	campana-campana incluye 3 empaques	campana-campana incluye 3 empaques
	Código	Código	Código
42" x 4"(1050mm x 100mm)	4260AN	4260AN85B	4260AN65B
42" x 6"(1050mm x 150mm)	4261AN	4261AN85B	4261AN65B
42" x 8"(1050mm x 200mm)	4262AN	4262AN85B	4262AN65B
42" x 10"(1050mm x 250mm)	4263AN	4263AN85B	4263AN65B
42" x 12"(1050mm x 300mm)	4264AN	4264AN85B	4264AN65B
42"x 15"(1050mm x 375mm)	4265AN	4265AN85B	4265AN65B
42" x 18"(1050mm x 450mm)	4266AN	4266AN85B	4266AN65B
42" x 24"(1050mm x 600mm)	4267AN	4267AN85B	4267AN65B
42" x 30"(1050mm x 750mm)	4268AN	4268AN85B	4268AN65B
42" x 36"(1050mm x 900mm)	4269AN	4269AN85B	4269AN65B
48" x 4"(1200mm x 100mm)	4860AN	4860AN85B	4860AN65B
48" x 6"(1200mm x 150mm)	4861AN	4861AN85B	4861AN65B
48" x 8"(1200mm x 200mm)	4862AN	4862AN85B	4862AN65B
48" x 10"(1200mm x 250mm)	4863AN	4863AN85B	4863AN65B
48" x 12"(1200mm x 300mm)	4864AN	4864AN85B	4864AN65B
48" x 15"(1200mm x 375mm)	4865AN	4865AN85B	4865AN65B
48"x18"(1200mm x 450mm)	4866AN	4866AN85B	4866AN65B
48" x 24"(1200mm x 600mm)	4867AN	4867AN85B	4867AN65B
48" x 30"(1200mm x 750mm)	4868AN	4868AN85B	4868AN65B
48" x 36"(1200mm x 900mm)	4869AN	4869AN85B	4869AN65B
48" x 42"(1200mm x 1050mm)	4840AN	4840AN85B	4840AN65B
60" x 4"(1500mm x 100mm)	6060AN	6060AN85B	6060AN65B
60" x 6"(1500mm x 150mm)	6061AN	6061AN85B	6061AN65B
60" x 8"(1500mm x 200mm)	6062AN	6062AN85B	6062AN65B
60" x 10"(1500mm x 250mm)	6063AN	6063AN85B	6063AN65B
60" x 12"(1500mm x 300mm)	6064AN	6064AN85B	6064AN65B
60" x 15"(1500mm x 375mm)	6065AN	6065AN85B	6065AN65B
60" x 18"(1500mm x 450mm)	6066AN	6066AN85B	6066AN65B
60" x 24"(1500mm x 600mm)	6067AN	6067AN85B	6067AN65B
60" x 30"(1500mm x 750mm)	6068AN	6068AN85B	6068AN65B
60" x 36"(1500mm x 900mm)	6069AN	6069AN85B	6069AN65B
60" x 42"(1500mm x 1050mm)	6040AN	6040AN85B	6040AN65B
60" x 48"(1500mm x 1200mm)	6041AN	6041AN85B	6041AN65B

Vista frontal

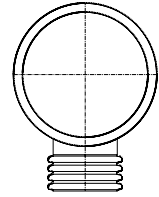

Vista superior

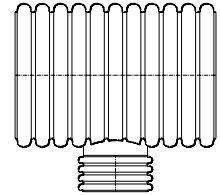

TEE reductor
espiga - espiga

Vista superior

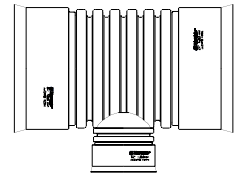

TEE reductor
campana - campana

N-12 ST & N-12 WT

Tee reductor / Tee en cruz

Accesorios para tubo de pared doble

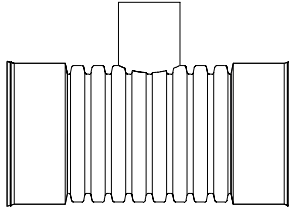

TEE reductor derivación en liso corrugado con campana

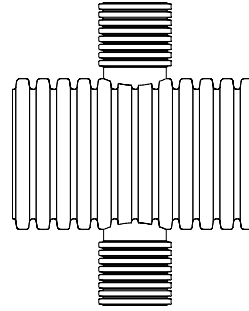

TEE reductor en cruz espiga - espiga

TEE REDUCTOR

Diámetros	campana-campana incluye 2 empaques
	Código
6"x4"(150mm x 100mm)	0660AN65BS
8"x4"(200mm x 100mm)	0860AN65BS
8"x6"(200mm x 150mm)	0861AN65BS
10"x4"(250mm x 100mm)	1060AN65BS
10"x6"(250mm x 150mm)	1061AN65BS
10"x8"(250mm x 200mm)	1062AN65BS
12"x4"(300mm x 100mm)	1260AN65BS
12"x6"(300mm x 150mm)	1261AN65BS
12"x8"(300mm x 200mm)	1262AN65BS
15"x4"(375mm x 100mm)	1560AN65BS
15"x6"(375mm x 150mm)	1561AN65BS
15"x8"(375mm x 200mm)	1562AN65BS
18"x4"(450mm x 100mm)	1860AN65BS
18"x6"(450mm x 150mm)	1861AN65BS
18"x8"(450mm x 200mm)	1862AN65BS
24"x4"(600mm x 100mm)	2460AN65BS
24"x6"(600mm x 150mm)	2461AN65BS
24"x8"(600mm x 200mm)	2462AN65BS
30"x4"(750mm x 100mm)	3060AN65BS
30"x6"(750mm x 150mm)	3061AN65BS
30"x8"(750mm x 200mm)	3062AN65BS
36"x4"(750mm x 100mm)	3660AN65BS
36"x6"(750mm x 150mm)	3661AN65BS
36"x8"(750mm x 200mm)	3662AN65BS

TEE REDUCTOR EN CRUZ

Diámetros	espiga-espiga
	Código
6"x4"(150mm x 100mm)	0630AN
8"x4"(200mm x 100mm)	0830AN
8"x6"(200mm x 150mm)	0831AN
10"x4"(250mm x 100mm)	1030AN
10"x6"(250mm x 150mm)	1031AN
10"x8"(250mm x 200mm)	1032AN
12"x4"(300mm x 100mm)	1230AN
12"x6"(300mm x 150mm)	1231AN
12"x8"(300mm x 200mm)	1232AN
12"x10"(300mm x 250mm)	1233AN

-Precios Enero 2022

*Póngase en contacto con su representante de ventas local para la disponibilidad de precios no listados en la tabla.

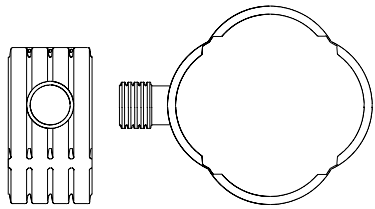

Silleta reductora cople abierto

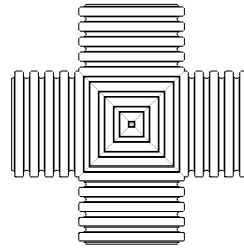

TEE en cruz
espiga - espiga

SILLETA

Diámetros	espiga-espiga
	Código
8" x 4" (200 mm x 100 mm)	0840AN
10" x 4" (250 mm x 100 mm)	1040AN
10" x 6" (250 mm x 150 mm)	1041AN
12" x 4" (300 mm x 100 mm)	1240AN
12" x 6" (300 mm x 150 mm)	1241AN
12" x 8" (300 mm x 200 mm)	1242AN
15" x 4" (375 mm x 100 mm)	1540AN
15" x 6" (375 mm x 150 mm)	1541AN
15" x 8" (375 mm x 200 mm)	1542AN
18" x 4" (450 mm x 100 mm)	1840AN
18" x 6" (450 mm x 150 mm)	1841AN
18" x 8" (450 mm x 200 mm)	1842AN
24" x 4" (600 mm x 100 mm)	2440AN
24" x 6" (600 mm x 150 mm)	2441AN
24" x 8" (600 mm x 200 mm)	2442AN
24" x 10" (600 mm x 250 mm)	2443AN
30" x 4" (750 mm x 100 mm)	3040AN
30" x 6" (750 mm x 150 mm)	3041AN
30" x 8" (750 mm x 200 mm)	3042AN
30" x 10" (750 mm x 250 mm)	3043AN
30" x 12" (750 mm x 300 mm)	3044AN
30" x 15" (750 mm x 375 mm)	3045AN
36" x 4" (900 mm x 100 mm)	3641AN
36" x 6" (900 mm x 150 mm)	3640AN
36" x 8" (900 mm x 200 mm)	3642AN
36" x 10" (900 mm x 250 mm)	3643AN
36" x 12" (900 mm x 300 mm)	3644AN
36" x 15" (900 mm x 375 mm)	3645AN
36" x 18" (900 mm x 450 mm)	3646AN

TEE EN CRUZ

Diámetros	espiga-espiga
	Código
4" (100mm)	0430ANZ
6" (150mm)	0631AN
8" (200mm)	0832AN
10" (250mm)	1033AN
12" (300mm)	1234AN
15" (375mm)	1535AN
18" (450mm)	1836AN
24" (600mm)	2437AN

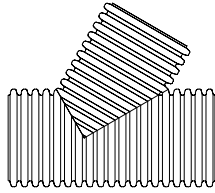

YEE a 45°
espiga - espiga

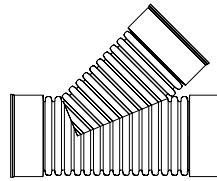

YEE a 45°
campana - campana

12" - 24" YEE FABRICADA A 45°

Diámetros	espiga-espiga	campana-campana incluye 3 empaques
	Código	Código
12" (300mm)	1284AN	1284AN65B
15" (375mm)	1585AN	1585AN65B
18" (450mm)	1886AN	1886AN65B
24" (600mm)	2487AN	2487AN65B

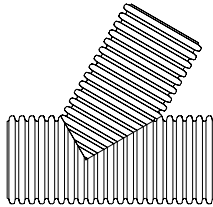

YEE a 60°
espiga - espiga

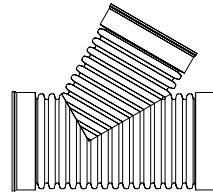

YEE a 60°
campana - campana

18" - 24" YEE FABRICADA A 60°

Diámetros	espiga-espiga	campana-campana incluye 3 empaques
	Código	Código
18" (450mm)	1886AN60	1886AN6065B
24" (600mm)	2487AN60	2487AN6065B

10" - 60" YEE REDUCTORA FABRICADA A 45°

Diámetros	espiga-espiga	campana-campana Incluye 3 empaques	campana-campana Incluye 3 empaques
	Código	Código	Código
10"x4" (250mm x 100mm)	1080AN		
10"x6" (250mm x 150mm)	1081AN		
10"x8" (250mm x 200mm)	1082AN		
12"x4" (300mm x 100mm)	1280AN	1280AN85B	1280AN65B
12"x6" (300mm x 150mm)	1281AN	1281AN85B	1281AN65B
12"x8" (300mm x 200mm)	1282AN	1282AN85B	1282AN65B
12"x10" (300mm x 250mm)	1283AN	1283AN85B	1283AN65B
15"x4" (375mm x 100mm)	1580AN	1580AN85B	1580AN65B
15"x6" (375mm x 150mm)	1581AN	1581AN85B	1581AN65B
15"x8" (375mm x 200mm)	1582AN	1582AN85B	1582AN65B
15"x10" (375mm x 250mm)	1583AN	1583AN85B	1583AN65B
15"x12" (375mm x 300mm)	1584AN	1584AN85B	1584AN65B
18"x4" (450mm x 100mm)	1880AN	1880AN85B	1880AN65B
18"x6" (450mm x 150mm)	1881AN	1881AN85B	1881AN65B
18"x8" (450mm x 200mm)	1882AN	1882AN85B	1882AN65B
18"x10" (450mm x 250mm)	1883AN	1883AN85B	1883AN65B
18"x12" (450mm x 300mm)	1884AN	1884AN85B	1884AN65B
18"x15" (450mm x 375mm)	1885AN	1885AN85B	1885AN65B
24"x4" (600mm x 100mm)	2480AN	2480AN85B	2480AN65B
24"x6" (600mm x 150mm)	2481AN	2481AN85B	2481AN65B
24"x8" (600mm x 200mm)	2482AN	2482AN85B	2482AN65B
24"x10" (600mm x 250mm)	2483AN	2483AN85B	2483AN65B
24"x12" (600mm x 300mm)	2484AN	2484AN85B	2484AN65B
30"x4" (750mm x 100mm)	3080AN	3080AN85B	3080AN65B
30"x6" (750mm x 150mm)	3081AN	3081AN85B	3081AN65B
30"x8" (750mm x 200mm)	3082AN	3082AN85B	3082AN65B
30"x10" (750mm x 250mm)	3083AN	3083AN85B	3083AN65B
30"x12" (750mm x 300mm)	3084AN	3084AN85B	3084AN65B
30"x15" (750mm x 375mm)	3085AN	3085AN85B	3085AN65B
36"x4" (900mm x 100mm)	3680AN	3680AN85B	3680AN65B
36"x6" (900mm x 150mm)	3681AN	3681AN85B	3681AN65B
36"x8" (900mm x 200mm)	3682AN	3682AN85B	3682AN65B
36"x10" (900mm x 250mm)	3683AN	3683AN85B	3683AN65B
36"x12" (900mm x 300mm)	3684AN	3684AN85B	3684AN65B
36"x15" (900mm x 375mm)	3685AN	3685AN85B	3685AN65B
36"x18" (900mm x 450mm)	3686AN	3686AN85B	3686AN65B
42"x4" (1050mm x 100mm)	4280AN	4280AN85B	4280AN65B
42"x6" (1050mm x 150mm)	4281AN	4281AN85B	4281AN65B
42"x8" (1050mm x 200mm)	4282AN	4282AN85B	4282AN65B
42"x10" (1050mm x 250mm)	4283AN	4283AN85B	4283AN65B
42"x12" (1050mm x 300mm)	4284AN	4284AN85B	4284AN65B
42"x15" (1050mm x 375mm)	4285AN	4285AN85B	4285AN65B
42"x18" (1050mm x 450mm)	4286AN	4286AN85B	4286AN65B
48"x4" (1200mm x 100mm)	4880AN	4880AN85B	4880AN65B
48"x6" (1200mm x 150mm)	4881AN	4881AN85B	4881AN65B
48"x8" (1200mm x 200mm)	4882AN	4882AN85B	4882AN65B
48"x10" (1200mm x 250mm)	4883AN	4883AN85B	4883AN65B
48"x12" (1200mm x 300mm)	4884AN	4884AN85B	4884AN65B
48"x15" (1200mm x 375mm)	4885AN	4885AN85B	4885AN65B
48"x18" (1200mm x 450mm)	4886AN	4886AN85B	4886AN65B
48"x24" (1200mm x 600mm)	4887AN	4887AN85B	4887AN65B
60"x4" (1500mm x 100mm)	6080AN	6080AN85B	6080AN65B
60"x6" (1500mm x 150mm)	6081AN	6081AN85B	6081AN65B
60"x8" (1500mm x 200mm)	6082AN	6082AN85B	6082AN65B
60"x10" (1500mm x 250mm)	6083AN	6083AN85B	6083AN65B
60"x12" (1500mm x 300mm)	6084AN	6084AN85B	6084AN65B
60"x15" (1500mm x 375mm)	6085AN	6085AN85B	6085AN65B
60"x18" (1500mm x 450mm)	6086AN	6086AN85B	6086AN65B
60"x24" (1500mm x 600mm)	6087AN	6087AN85B	6087AN65B

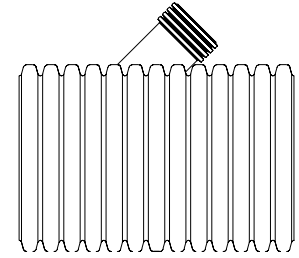

YEE reductora a 45°
espiga - espiga

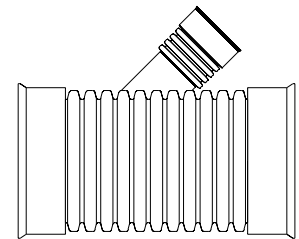

YEE reductora a 45°
campana - campana

18" - 60" YEES REDUCTORA FABRICADA A 60°

Diámetros	espiga-espiga	campana-campana incluye 3 empaques	campana-campana incluye 3 empaques
	Código	Código	Código
18"x4"(450mm x 100mm)	1880AN60	1880AN6065B	1880AN6065B
18"x6"(450mm x 150mm)	1881AN60	1881AN6065B	1881AN6065B
18"x8"(450mm x 200mm)	1882AN60	1882AN6065B	1882AN6065B
18"x10"(450mm x 250mm)	1883AN60	1883AN6065B	1883AN6065B
18"x12"(450mm x 300mm)	1884AN60	1884AN6065B	1884AN6065B
18"x15"(450mm x 375mm)	1885AN60	1885AN6065B	1885AN6065B
24"x4"(600mm x 100mm)	2480AN60	2480AN6065B	2480AN6065B
24"x6"(600mm x 150mm)	2481AN60	2481AN6065B	2481AN6065B
24"x8"(600mm x 200mm)	2482AN60	2482AN6065B	2482AN6065B
24"x10"(600mm x 250mm)	2483AN60	2483AN6065B	2483AN6065B
24"x12"(600mm x 300mm)	2484AN60	2484AN6065B	2484AN6065B
24"x15"(600mm x 375mm)	2485AN60	2485AN6065B	2485AN6065B
24"x18"(600mm x 450mm)	2486AN60	2486AN6065B	2486AN6065B
30"x4"(750mm x 100mm)	3080AN60	3080AN6065B	3080AN6065B
30"x6"(750mm x 150mm)	3081AN60	3081AN6065B	3081AN6065B
30"x8"(750mm x 200mm)	3082AN60	3082AN6065B	3082AN6065B
30"x10"(750mm x 250mm)	3083AN60	3083AN6065B	3083AN6065B
30"x12"(750mm x 300mm)	3084AN60	3084AN6065B	3084AN6065B
30"x15"(750mm x 375mm)	3085AN60	3085AN6065B	3085AN6065B
30"x18"(750mm x 450mm)	3086AN60	3086AN6065B	3086AN6065B
30"x24"(750mm x 600mm)	3087AN60	3087AN6065B	3087AN6065B
36"x4"(900mm x 100mm)	3680AN60	3680AN6065B	3680AN6065B
36"x6"(900mm x 150mm)	3681AN60	3681AN6065B	3681AN6065B
36"x8"(900mm x 200mm)	3682AN60	3682AN6065B	3682AN6065B
36"x10"(900mm x 250mm)	3683AN60	3683AN6065B	3683AN6065B
36"x12"(900mm x 300mm)	3684AN60	3684AN6065B	3684AN6065B
36"x15"(900mm x 375mm)	3685AN60	3685AN6065B	3685AN6065B
36"x18"(900mm x 450mm)	3686AN60	3686AN6065B	3686AN6065B
36"x24"(900mm x 600mm)	3687AN60	3687AN6065B	3687AN6065B
42"x4"(1050mm x 100mm)	4280AN60	4280AN6065B	4280AN6065B
42"x6"(1050mm x 150mm)	4281AN60	4281AN6065B	4281AN6065B
42"x8"(1050mm x 200mm)	4282AN60	4282AN6065B	4282AN6065B
42"x10"(1050mm x 250mm)	4283AN60	4283AN6065B	4283AN6065B
42"x12"(1050mm x 300mm)	4284AN60	4284AN6065B	4284AN6065B
42"x15"(1050mm x 375mm)	4285AN60	4285AN6065B	4285AN6065B
42"x18"(1050mm x 450mm)	4286AN60	4286AN6065B	4286AN6065B
42"x24"(1050mm x 600mm)	4287AN60	4287AN6065B	4287AN6065B
48"x4"(1200mm x 100mm)	4880AN60	4880AN6065B	4880AN6065B
48"x6"(1200mm x 150mm)	4881AN60	4881AN6065B	4881AN6065B
48"x8"(1200mm x 200mm)	4882AN60	4882AN6065B	4882AN6065B
48"x10"(1200mm x 250mm)	4883AN60	4883AN6065B	4883AN6065B
48"x12"(1200mm x 300mm)	4884AN60	4884AN6065B	4884AN6065B
48"x15"(1200mm x 375mm)	4885AN60	4885AN6065B	4885AN6065B
48"x18"(1200mm x 450mm)	4886AN60	4886AN6065B	4886AN6065B
48"x24"(1200mm x 600mm)	4887AN60	4887AN6065B	4887AN6065B
60"x4"(1500mm x 100mm)	6080AN60	6080AN6065B	6080AN6065B
60"x6"(1500mm x 150mm)	6081AN60	6081AN6065B	6081AN6065B
60"x8"(1500mm x 200mm)	6082AN60	6082AN6065B	6082AN6065B
60"x10"(1500mm x 250mm)	6083AN60	6083AN6065B	6083AN6065B
60"x12"(1500mm x 300mm)	6084AN60	6084AN6065B	6084AN6065B
60"x15"(1500mm x 375mm)	6085AN60	6085AN6065B	6085AN6065B
60"x18"(1500mm x 450mm)	6086AN60	6086AN6065B	6086AN6065B
60"x24"(1500mm x 600mm)	6087AN60	6087AN6065B	6087AN6065B

Vista superior

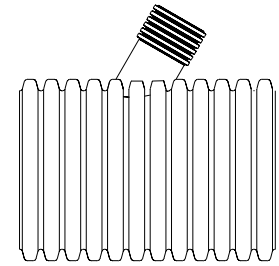

Vista frontal

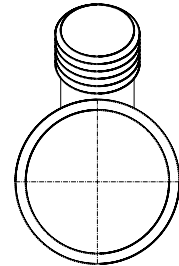

YEE reductora a 60°
espiga - espiga

Vista superior

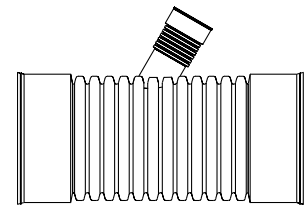

YEE reductora a 60°
campana - campana

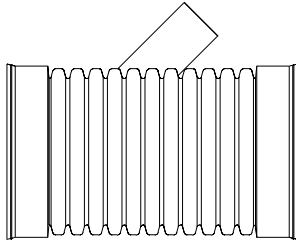

YEE reductora a 45° con derivación en liso campana - campana

YEES REDUCTORA A 45°

Diámetros	campana-campana incluye 2 empaques
	Código
6"x4"(150mm x 100mm)	0680AN65BS
8"x4"(200mm x 100mm)	0880AN65BS
8"x6"(200mm x 150mm)	0881AN65BS
10"x4"(250mm x 100mm)	1080AN65BS
10"x6"(250mm x 150mm)	1081AN65BS
10"x8"(250mm x 200mm)	1082AN65BS
12"x4"(300mm x 100mm)	1280AN65BS
12"x6"(300mm x 150mm)	1281AN65BS
12"x8"(300mm x 200mm)	1282AN65BS
15"x4"(375mm x 100mm)	1580AN65BS
15"x6"(375mm x 150mm)	1581AN65BS
15"x8"(375mm x 200mm)	1582AN65BS
18"x4"(450mm x 100mm)	1880AN65BS
18"x6"(450mm x 150mm)	1881AN65BS
18"x8"(450mm x 200mm)	1882AN65BS
24"x4"(600mm x 100mm)	2480AN65BS
24"x6"(600mm x 150mm)	2481AN65BS
24"x8"(600mm x 200mm)	2482AN65BS
30"x4"(750mm x 100mm)	3080AN65BS
30"x6"(750mm x 150mm)	3081AN65BS
30"x8"(750mm x 200mm)	3082AN65BS

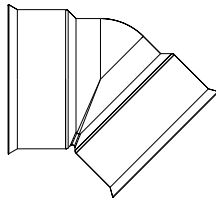

45° Codo inyectado

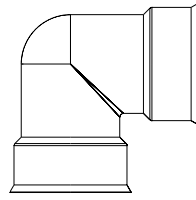

90° Codo inyectado

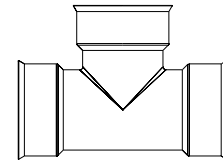

TEE

CODO A 45°

Diámetros	Código
4" (100mm)	0494ST
6" (150mm)	0694ST
8" (200mm)	0894ST
10" (250mm)	1094ST
12" (300mm)	1294ST

- No incluye empaques

CODO A 90°

Diámetros	Código
4" (100mm)	0499ST
6" (150mm)	0699ST
8" (200mm)	0899ST
10" (250mm)	1099ST
12" (300mm)	1299ST

- No incluye empaques

TEE

Diámetros	Código
4" (100mm)	0460ST
6" (150mm)	0661ST
8" (200mm)	0862ST
10" (250mm)	1063ST
12" (300mm)	1264ST

- No incluye empaques

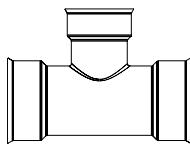

TEE reductora

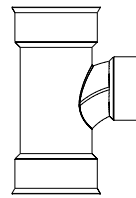

TEE en YEE

TEE REDUCTORA

Diámetros	Código
6" x 4" (150 x 100 mm)	0660ST
10" x 8" (250 x 200 mm) 12"	1062ST
x 8" (300 x 200 mm)	1262ST

- No incluye empaques

TEE EN YEE

Diámetros	Código
8" x 4" (200 x 100mm)	0863ST
8" x 6" (200 x 150mm)	0836ST
10" x 6" (250 x 150mm)	1036ST

- Incluye empaques

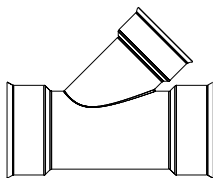

45° YEE reductora

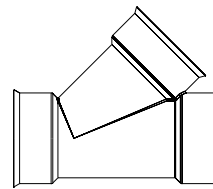

45° YEE inyectada

YEE REDUCTORA A 45°

Diámetros	Código
6" x 4" (150 x 100mm)	0680ST
8" x 4" (200 x 100mm)	0880ST
8" x 6" (200 x 150mm)	0881ST
10" x 8" (250 x 200mm)	1082ST

- No incluye empaques

YEE A 45°

Diámetros	Código
4" (100mm)	0480ST
6" (150mm)	0681ST
8" (200mm)	0882ST
10" (250mm)	1083ST
12" (300mm)	1284ST

- No incluye empaques

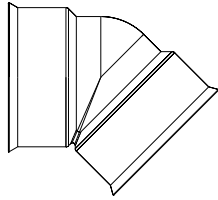

45° Codo inyectado

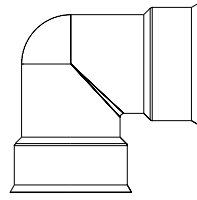

90° Codo inyectado

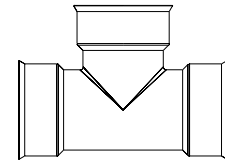

TEE

CODO A 45°

Diámetros	Código
4" (100mm)	0494WT
6" (150mm)	0694WT
8" (200mm)	0894WT
10" (250mm)	1094WT
12" (300mm)	1294WT

- No incluye empaques

CODO A 90°

Diámetros	Código
4" (100mm)	0499WT
6" (150mm)	0699WT
8" (200mm)	0899WT
10" (250mm)	1099WT
12" (300mm)	1299WT

- No incluye empaques

TEE

Diámetros	Código
4" (100mm)	0460WT
6" (150mm)	0661WT
8" (200mm)	0862WT
10" (250mm)	1063WT
12" (300mm)	1264WT

- No incluye empaques

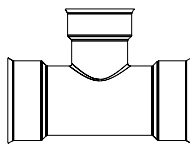

TEE reductora

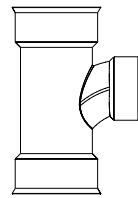

TEE en YEE

TEE REDUCTORA

Diámetros	Código
6" x 4" (150 x 100 mm)	0660WT
10" x 8" (250 x 200 mm) 12" x 8" (300 x 200 mm)	1062WT 1262WT

- No incluye empaques

TEE EN YEE

Diámetros	Código
8" x 4" (200 x 100mm)	0863WT
8" x 6" (200 x 150mm)	0836WT
10" x 6" (250 x 150mm)	1036WT
12" x 6" (300 x 150mm)	1236WT

- Incluye empaques

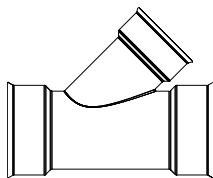

45° YEE reductora

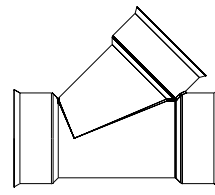

45° YEE inyectada

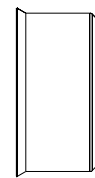

Tapa

YEE REDUCTORA A 45°

Diámetros	Código
6" x 4" (150 x 100mm)	0680WT
8" x 4" (200 x 100mm)	0880WT
8" x 6" (200 x 150mm)	0881WT
10" x 8" (250 x 200mm)	1082WT
12" x 6" (300 x 150mm)	1281WT
12" x 8" (300 x 200mm)	1282WT

- No incluye empaques

YEE A 45°

Diámetros	Código
4" (100mm)	0480WT
6" (150mm)	0681WT
8" (200mm)	0882WT
10" (250mm)	1083WT
12" (300mm)	1284WT

- No incluye empaques

TAPA

Diámetros	Código
4" (100mm)	0432WT
6" (150mm)	0632WT

- No incluye empaques

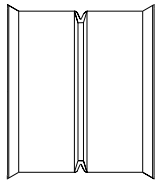

Cople campana - campana

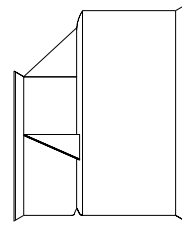

Cople reductor campana - campana

COPLER CAMPANA - CAMPANA

Diámetros	Código	Precio
4" (100mm)	0413WT	\$ 6.90
6" (150mm)	0613WT	\$ 10.12
8" (200mm)	0813WT	\$ 15.18
10" (250mm)	1013WT	\$ 64.76

- No incluye empaques

COPLER REDUCTOR CAMPANA - CAMPANA

Diámetros	Código	Precio
6" x 4" (150 x 100mm)	0614WT	\$ 13.54
8" x 4" (200 x 100mm)	0814WT	\$ 18.42
8" x 6" (200 x 150mm)	0816WT	\$ 22.28
10" x 8" (250 x 200mm)	1018WT	\$ 49.79
12" x 8" (300 x 200mm)	1218WT	\$ 54.84
12" x 10" (300 x 250mm)	1210WT	\$ 58.59

- No incluye empaques

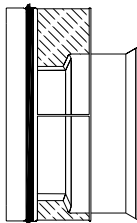

Cople reductor espiga - campana

COPLER REDUCTOR ESPIGA - CAMPANA

Diámetros	Código
6" x 4" (150 x 100mm)	0674WT
8" x 4" (200 x 100mm)	0874WT
8" x 6" (200 x 150mm)	0876WT

- No incluye empaques

Juego de accesorios reductores moldeados por inyección

Accesorios para tubo de pared doble

TEE		
Diámetros	Consiste en TEE + Reductor	Código
10"x4"(250mm x 100mm)	1062WT 10" x 8" + 0874WT 8" x 4"	1060ST
12"x10"(300mm x 250mm)	1264ST 12" + 1210WT 12" x 10"	1 ² 1263ST

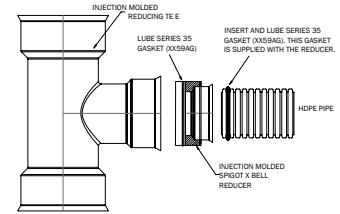

TEE		
Diámetros	Consiste en TEE + Reductor	Código
10"x4"(250mm x 100mm)	1062WT 10" x 8" + 0874WT 8" x 4"	1060WT
12"x4"(300mm x 100mm)	1262WT 12" x 8" + 0874WT 8" x 4"	1260WT
12"x10"(300mm x 250mm)	1264WT 12" + 1210WT 12" x 10"	1 ² 1263WT

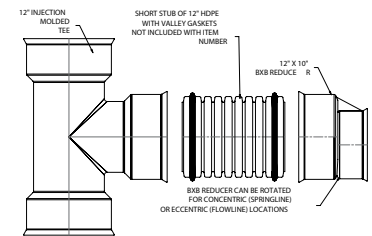

YEE		
Diámetros	Consiste en TEE + Reductor	Código
12"x10"(300mm x 250mm)	1284WT 12" + 1210WT 12" x 10"	1283ST

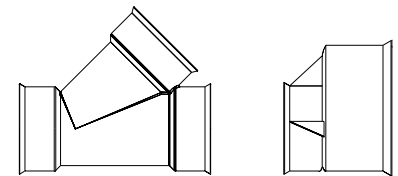

YEE		
Diámetros	Consiste en TEE + Reductor	Código
10"x4"(250mm x 100mm)	1082WT 10" x 8" + 0874WT 8" x 4"	1080WT
10"x6"(250mm x 150mm)	1082WT 10" x 8" + 0876WT 8" x 6"	1081WT
12"x4"(300mm x 100mm)	1282WT 12" x 8" + 0874WT 8" x 4"	1280WT
12"x10"(300mm x 250mm)	1284WT 12" + 1210WT 12" x 10"	1283WT

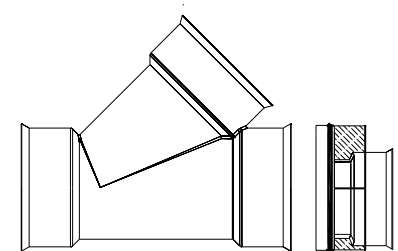

REDUCTORES		
Diámetros	Consiste en TEE + Reductor	Código
10"x4"(250mm x 100mm)	1018WT 10" x 8" + 0874WT 8" x 4"	1074WT
10"x6"(250mm x 150mm)	1018WT 10" x 8" + 0876WT 8" x 6"	1076WT
12"x4"(300mm x 100mm)	1218WT 12" x 8" + 0874WT 8" x 4"	1274WT
12"x6"(300mm x 150mm)	1218WT 12" x 8" + 0876WT 8" x 6"	1276WT

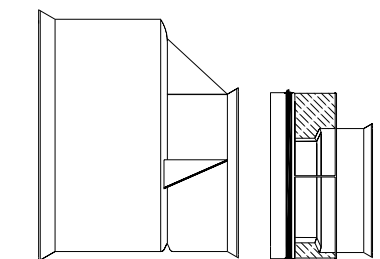

1. No se entrega la tubería necesaria para hacer las conexiones, ordene estos tubos por separado.

2. TEE 12" x 10": Ordene una TEE 1264WT 12" x 12" + reductor campana - campana 1210WT 12" x 10" y corte un tramo de tubo aproximadamente entre 12" a 15" para hacer la conexión entre las 2 campanas.

Empaques	
Descripción	Código
02".EMPAQUE.SANITARIO - PERFIL ADS	0259AG
03".EMPAQUE.SANITARIO - PERFIL ADS	0359AG
04".EMPAQUE.SANITARIO - PERFIL ADS	0459AG
06" EMPAQUE P/TUBERIA - ACCESORIOS/FITTINGS	0632NPAZ*
06" EMPAQUE P/TUBERIA - PERFIL ADSM	0632NPZ
08" EMPAQUE P/TUBERIA - PERFIL ADSM	0832NP
08" EMPAQUE P/TUBERIA ACCESORIOS/FITTINGS	0832NPA*
10".EMPAQUE.SANITARIO	1059AG
12" EMPAQUE EMPAQUE P/TUBERIA - ACCESORIOS/FITTINGS	1232NPAZ*
15" N-12 WT VALLEY GASKET	1559AGZ
18" N-12 WT VALLEY GASKET	1859AGZ
24" N-12 WT VALLEY GASKET	2459AGZ
30" N-12 WT VALLEY GASKET.(GREEN STRIPE)	3063MGZ
36" WT VALLEY GASKET	3665MGZ
42" WT SADDLE GASKET.(A)	4265MGZ
48" WT SADDLE GASKET.(A)	4865MGZ
60" WT SADDLE GASKET	6065MGZ

*Códigos compatibles para unión de accesorios y tubería en diámetros 06", 08" y 12".

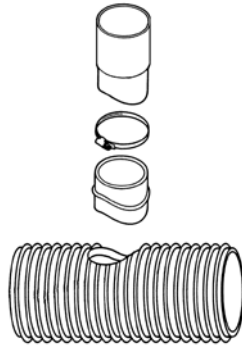

INSERTA TEE	
Diámetros	Código
4" conecta en 6" (100mm conecta en 150mm)	4N126N12
4" conecta en 8" (100mm conecta en 200mm)	4N128N12
4" conecta en 10" (100mm conecta en 250mm)	4N1210N12
4" conecta en 12" (100mm conecta en 300mm)	4N1212N12
4" conecta en 15" (100mm conecta en 375mm)	4N1215N12
4" conecta en 18" (100mm conecta en 450mm)	4N1218N12
4" conecta en 24" (100mm conecta en 600mm)	4N1224N12
4" conecta en 30" (100mm conecta en 750mm)	4N1230N12
4" conecta en 36" (100mm conecta en 900mm)	4N1236N12
4" conecta en 42" (100mm conecta en 1050mm)	4N1242N12
4" conecta en 48" (100mm conecta en 1200mm)	4N1248N12
4" conecta en 60" (100mm conecta en 1500mm)	4N1260N12
6" conecta en 8" (150mm conecta en 200mm)	6N128N12
6" conecta en 10" (150mm conecta en 250mm)	6N1210N12
6" conecta en 12" (150mm conecta en 300mm)	6N1212N12
6" conecta en 15" (150mm conecta en 375mm)	6N1215N12
6" conecta en 18" (150mm conecta en 450mm)	6N1218N12
6" conecta en 24" (150mm conecta en 600mm)	6N1224N12
6" conecta en 30" (150mm conecta en 750mm)	6N1230N12
6" conecta en 36" (150mm conecta en 900mm)	6N1236N12
6" conecta en 42" (150mm conecta en 1050mm)	6N1242N12
6" conecta en 48" (150mm conecta en 1200mm)	6N1248N12
6" conecta en 60" (150mm conecta en 1500mm)	6N1260N12
8" conecta en 10" (200mm conecta en 250mm)	8N1210N12
8" conecta en 12" (200mm conecta en 300mm)	8N1212N12
8" conecta en 15" (200mm conecta en 375mm)	8N1215N12
8" conecta en 18" (200mm conecta en 450mm)	8N1218N12
8" conecta en 24" (200mm conecta en 600mm)	8N1224N12
8" conecta en 30" (200mm conecta en 750mm)	8N1230N12
8" conecta en 36" (200mm conecta en 900mm)	8N1236N12
8" conecta en 42" (200mm conecta en 1050mm)	8N1242N12
8" conecta en 48" (200mm conecta en 1200mm)	8N1248N12
8" conecta en 60" (200mm conecta en 1500mm)	8N1260N12

INSERTA TEE	
Diámetros	Código
10" conecta en 12" (250mm conecta en 300mm)	10N1212N121
10" conecta en 15" (250mm conecta en 375mm)	0N1215N1210
10" conecta en 18" (250mm conecta en 450mm)	N1218N1210N
10" conecta en 24" (250mm conecta en 600mm)	1224N1210N1
10" conecta en 30" (250mm conecta en 750mm)	230N1210N12
10" conecta en 36" (250mm conecta en 900mm)	36N1210N124
10" conecta en 42" (250mm conecta en 1050mm)	2N1210N1248
10" conecta en 48" (250mm conecta en 1200mm)	N1210N1260N
10" conecta en 60" (250mm conecta en 1500mm)	1212N1215N1
12" conecta en 15" (300mm conecta en 375mm)	212N1218N12
12" conecta en 18" (300mm conecta en 450mm)	12N1224N121
12" conecta en 24" (300mm conecta en 600mm)	2N1230N1212
12" conecta en 30" (300mm conecta en 750mm)	N1236N1212N
12" conecta en 36" (300mm conecta en 900mm)	1242N1212N1
12" conecta en 42" (300mm conecta en 1050mm)	248N1212N12
12" conecta en 48" (300mm conecta en 1200mm)	60N1215N121
12" conecta en 60" (300mm conecta en 1500mm)	8N1215N1224
15" conecta en 18" (375mm conecta en 450mm)	N1215N1230N
15" conecta en 24" (375mm conecta en 600mm)	1215N1236N1
15" conecta en 30" (375mm conecta en 750mm)	215N1242N12
15" conecta en 36" (375mm conecta en 900mm)	15N1248N121
15" conecta en 42" (375mm conecta en 1050mm)	5N1260N1218
15" conecta en 48" (375mm conecta en 1200mm)	N1224N1218N
15" conecta en 60" (375mm conecta en 1500mm)	1230N1218N1
18" conecta en 24" (450mm conecta en 600mm)	236N1218N12
18" conecta en 30" (450mm conecta en 750mm)	42N1218N124
18" conecta en 36" (450mm conecta en 900mm)	8N1218N1260
18" conecta en 42" (450mm conecta en 1050mm)	N1224N1236N
18" conecta en 48" (450mm conecta en 1200mm)	1224N1242N1
18" conecta en 60" (450mm conecta en 1500mm)	224N1248N12
24" conecta en 36" (600mm conecta en 900mm)	24N1260N123
24" conecta en 42" (600mm conecta en 1050mm)	0N1242N1230
24" conecta en 48" (600mm conecta en 1200mm)	N1248N1230N
24" conecta en 60" (600mm conecta en 1500mm)	1260N12
30" conecta en 42" (750mm conecta en 1050mm)	
30" conecta en 48" (750mm conecta en 1200mm)	
30" conecta en 60" (750mm conecta en 1500mm)	

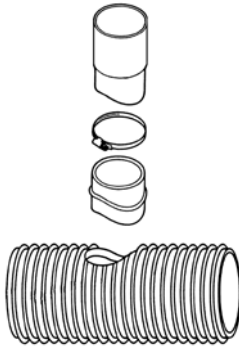

SDR35 CONECTA EN N-12 PLAIN END/N-12 ST/N-12 WT

Diámetros	Código
4" SDR35 conecta en 6" (100mm conecta en 150mm)	4P26FB6N12
4" SDR35 conecta en 8" (100mm conecta en 200mm)	4P26FB8N12
4" SDR35 conecta en 10" (100mm conecta en 250mm)	4P26FB10N12
4" SDR35 conecta en 12" (100mm conecta en 300mm)	4P26FB12N12
4" SDR35 conecta en 15" (100mm conecta en 375mm)	4P26FB15N12
4" SDR35 conecta en 18" (100mm conecta en 450mm)	4P26FB18N12
4" SDR35 conecta en 24" (100mm conecta en 600mm)	4P26FB24N12
4" SDR35 conecta en 30" (100mm conecta en 750mm)	4P26FB30N12
4" SDR35 conecta en 36" (100mm conecta en 900mm)	4P26FB36N12
4" SDR35 conecta en 42" (100mm conecta en 1050mm)	4P26FB42N12
4" SDR35 conecta en 48" (100mm conecta en 1200mm)	4P26FB48N12
4" SDR35 conecta en 60" (100mm conecta en 1500mm)	4P26FB60N12
6" SDR35 conecta en 8" (150mm conecta en 200mm)	6P26FB8N12
6" SDR35 conecta en 10" (150mm conecta en 250mm)	6P26FB10N12
6" SDR25 conecta en 12" (150mm conecta en 300mm)	6P26FB12N12
6" SDR35 conecta en 15" (150mm conecta en 375mm)	6P26FB15N12
6" SDR35 conecta en 18" (150mm conecta en 450mm)	6P26FB18N12
6" SDR35 conecta en 24" (150mm conecta en 600mm)	6P26FB24N12
6" SDR35 conecta en 30" (150mm conecta en 750mm)	6P26FB30N12
6" SDR35 conecta en 36" (150mm conecta en 900mm)	6P26FB36N12
6" SDR35 conecta en 42" (150mm conecta en 1050mm)	6P26FB42N12
6" SDR35 conecta en 48" (150mm conecta en 1200mm)	6P26FB48N12
6" SDR35 conecta en 60" (150mm conecta en 1500mm)	6P26FB60N12
8" SDR35 conecta en 10" (200mm conecta en 250mm)	8P3510N12
8" SDR25 conecta en 12" (200mm conecta en 300mm)	8P3512N12
8" SDR35 conecta en 15" (200mm conecta en 375mm)	8P3515N12
8" SDR35 conecta en 18" (200mm conecta en 450mm)	8P3518N12
8" SDR35 conecta en 24" (200mm conecta en 600mm)	8P3524N12
8" SDR35 conecta en 30" (200mm conecta en 750mm)	8P3530N12
8" SDR35 conecta en 36" (200mm conecta en 900mm)	8P3536N12
8" SDR35 conecta en 42" (200mm conecta en 1050mm)	8P3542N12
8" SDR35 conecta en 48" (200mm conecta en 1200mm)	8P3548N12
8" SDR35 conecta en 60" (200mm conecta en 1500mm)	8P3560N12

SDR35 CONECTA EN N-12 PLAIN END/N-12 ST/N-12 WT

Diámetros	Código
10" SDR35 conecta en 12" (250mm conecta en 300mm)	10P3512N12
10" SDR35 conecta en 15" (250mm conecta en 375mm)	10P3515N12
10" SDR35 conecta en 18" (250mm conecta en 450mm)	10P3518N12
10" SDR35 conecta en 24" (250mm conecta en 600mm)	10P3524N12
10" SDR35 conecta en 30" (250mm conecta en 750mm)	10P3530N12
10" SDR35 conecta en 36" (250mm conecta en 900mm)	10P3536N12
10" SDR35 conecta en 42" (250mm conecta en 1050mm)	10P3542N12
10" SDR35 conecta en 48" (250mm conecta en 1200mm)	10P3548N12
10" SDR35 conecta en 60" (250mm conecta en 1500mm)	12P3560N12
12" SDR35 conecta en 15" (300mm conecta en 375mm)	12P3515N12
12" SDR35 conecta en 18" (300mm conecta en 450mm)	12P3518N12
12" SDR35 conecta en 24" (300mm conecta en 600mm)	12P3524N12
12" SDR35 conecta en 30" (300mm conecta en 750mm)	12P3530N12
12" SDR35 conecta en 36" (300mm conecta en 900mm)	12P3536N12
12" SDR35 conecta en 42" (300mm conecta en 1050mm)	12P3542N12
12" SDR35 conecta en 48" (300mm conecta en 1200mm)	12P3548N12
12" SDR35 conecta en 60" (300mm conecta en 1500mm)	12P3560N12
15" SDR35 conecta en 18" (375mm conecta en 450mm)	15P3518N12
15" SDR35 conecta en 24" (375mm conecta en 600mm)	15P3524N12
15" SDR35 conecta en 30" (375mm conecta en 750mm)	15P3530N12
15" SDR35 conecta en 36" (375mm conecta en 900mm)	15P3536N12
15" SDR35 conecta en 42" (375mm conecta en 1050mm)	15P3542N12
15" SDR35 conecta en 48" (375mm conecta en 1200mm)	15P3548N12
15" SDR35 conecta en 60" (375mm conecta en 1500mm)	15P3560N12
18" SDR35 conecta en 24" (450mm conecta en 600mm)	18P3524N12
18" SDR35 conecta en 30" (450mm conecta en 750mm)	18P3530N12
18" SDR35 conecta en 36" (450mm conecta en 900mm)	18P3536N12
18" SDR35 conecta en 42" (450mm conecta en 1050mm)	18P3542N12
18" SDR35 conecta en 48" (450mm conecta en 1200mm)	18P3548N12
18" SDR35 conecta en 60" (450mm conecta en 1500mm)	18P3560N12
24" SDR35 conecta en 36" (600mm conecta en 900mm)	24P3536N12
24" SDR35 conecta en 42" (600mm conecta en 1050mm)	24P3542N12
24" SDR35 conecta en 48" (600mm conecta en 1200mm)	24P3548N12
24" SDR35 conecta en 60" (600mm conecta en 1500mm)	24P3560N12
30" SDR35 conecta en 42" (750mm conecta en 1050mm)	30P3542N12
30" SDR35 conecta en 48" (750mm conecta en 1200mm)	30P3548N12
30" SDR35 conecta en 60" (750mm conecta en 1500mm)	30P3560N12

Sierra circular para conexión Inserta Tee®

Accesorios para tubo de pared doble

MODELO SIERRA AMARILLA

Diámetros	Broca guía	Peso	Código
4½"	¼"	0.90 kg	Y412
6½"	¼"	1.36 kg	Y612
8¾"	¼"	2.26 kg	Y834

MODELO SIERRA PLATEADA

Diámetros	Broca guía	Peso	Código
4½"	10mm	1.81 kg	S412
6½"	10mm	3.40 kg	S612
8¾"	10mm	5.66 kg	S834

MODELO SIERRA ROJA

Diámetros	Broca guía	Peso	Código
4½"	⅜"	1.13 kg	R412
6½"	⅜"	1.58 kg	R612
8¾"	⅜"	2.49 kg	R834
10⅞"	12mm	3.85 kg	R1078

MODELO SIERRA DORADA (PARA USO TALADRO MANUAL)

Diámetros	Broca guía	Peso	Código
4½"	¾"	5.44 kg	GA412
6½"	¾"	8.16 kg	GA612
8¾"	¾"	10.88 kg	GA834
10⅞"	¾"	14.96 kg	GA1078

MODELO SIERRA AZUL

Diámetros	Broca guía	Peso	Código
4½"	⅜"	1.13 kg	BL412
6½"	⅜"	1.58 kg	BL612
8¾"	⅜"	2.49 kg	BL834

MODELO SIERRA DORADA (PARA USO CON MAQUINA DE EXTRACCIÓN DE MUESTRAS)

Diámetros	Broca guía	Peso	Código
4½"	¾"	4.08 kg	G412
6½"	¾"	6.80 kg	G612
8¾"	¾"	9.52 kg	G834
10⅞"	¾"	13.60 kg	G1078
12⅞"	¾"	18.59 kg	G1278
15 ^{13/16"}	¾"	26.56 kg	G151316
19 ^{3/16"}	¾"	27.21 kg	G19316

MODELO SIERRA GRIS

Diámetros	Broca guía	Peso	Código
4½"	½"	2.72 kg	PE412
6½"	½"	3.74 kg	PE612

MODELO SIERRA NARANJA (PARA TUBO HP)

Diámetros	Pilot Drill	Peso	Código
4 ⅜"	12mm	1.36 kg	HP438SAW
6 ⅜"	12mm	1.81 kg	HP638SAW
8 ⅜"	12mm	2.72 kg	HP858SAW
10¾"	¾"	5.44 kg	HP1034SAW
12¾"	¾"	6.80 kg	HP1234SAW
15¾"	¾"	9.52 kg	HP1534SAW
19 ^{11/16"}	¾"	15.87 kg	HP19116SAW

COPELLE INTERNO A PRESIÓN

Diámetros	Cantidad	Código
3" (75mm)	50	0315AAZ
4" (100mm)	16	0417AAZ
6" (150mm)	9	0615AAZ
8" (200mm)	4	0815AAZ
10" (250mm)	4	1015AAZ

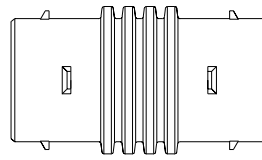

Cople interno a presión

COPELLE REDUCTOR INTERNO

Diámetros	Cantidad	Código
5" x 4" (125 x 100mm)	16	0425AAZ
6" x 5" (150 x 125mm)	9	0526AAZ

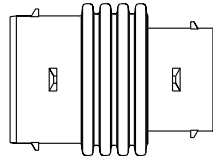

Cople reductor interno

COPELLE EXTERNO A PRESIÓN (SNAP)

Diámetros	Cantidad	Código
3" (75mm)	24	0312AAZ
4" (100mm)	24	0412AAZ 0412AABM
6" (150mm)	8	0612AAZ
8" (200mm)	6	0812AAZ
10" (250mm)	3	1012AAZ

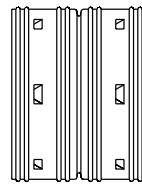

Cople externo a presión (SNAP)

COPELLE ABIERTO

Diámetros	Cantidad	Código
3" (75mm)	36	0311AAZ
4" (100mm)	24	0411AAZ
6" (150mm)	14	0611AAZ
8" (200mm)	8	0811AAZ
10" (250mm)	12	1011AAZ

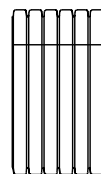

Cople abierto

TAPA*					
Diámetros	Cantidad		Tipo	Código Snap	Código abierto
	Snap	Abierto			
3" (75mm)	30	32	Sólido	0332AAZ	0331AAZ
4" (100mm)	40	34	Sólido	0432AAZ	0431AAZ
6" (150mm)		12	Sólido		0631AAZ
8" (200mm)	6		Sólido	0832AAZ	
10" (250mm)	6		Sólido	1032AAZ	
12" (300mm)		4	Sólido		1267AAZ
15" (375mm)		1	Sólido		1567AAZ
18" (450mm)		1	Sólido		1867AAZ
24" (600mm)		1	Sólido		2467AAZ

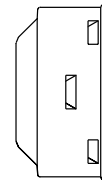

Tapa SNAP

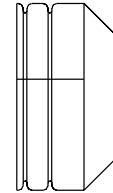

Tapa abierta de 3"-10"



Tapa abierta de 12"-24"

-Las tapas son solo para aplicaciones horizontales para el inicio de una red de tubería. No se permite que las tapas se utilicen en ninguna aplicación vertical. El mal uso o el mal aseguramiento en la colocación de las tapas puede resultar en daños a personas o propiedades o puede resultar en lesiones o la muerte.

TAPONES INTERNOS A PRESIÓN		
Diámetros	Cantidad	Código
3" (75mm)	16	0333AAZ
4" (100mm)	34	0433AAZ
5" (125mm)	24	0434AAZ
6" (150mm)	50	0633AAZ

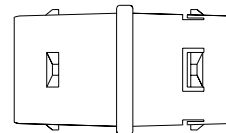

Tapón sólido

TAPONES			
Diámetros	Cantidad	Tipo	Código
3" (75mm)	100	Sólido	0333AAZ
4" (100mm)	100	Sólido	0433AAZ
		Perforado	0434AAZ
6" (150mm)	50	Sólido	0633AAZ



Tapón sólido

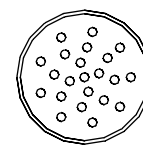
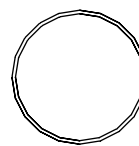

Tapón perforado

Adaptador y bajante / tubería flexible Bend-A-Drain™

Accesorios para tubo de pared doble

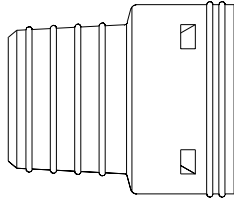

Adaptador

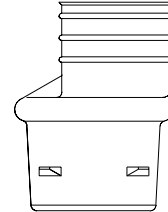

Bajante

ADAPTADOR

Diámetros	Cantidad	Tipo	Código
3" (75mm)	24	Arcilla	0362AAZ
4" (100mm)	24	Arcilla	0462AAZ
5" (125mm)	24	Arcilla	0562AAZ
6" (150mm)	11	Arcilla	0662AAHAN
8" (200mm)	9	Arcilla	0862AAZ
4" (100mm)	24	Drenaje	0467AAZ
4" (100mm)	24	Fosa séptica	0463AAZ

BAJANTE PARA PVC

Dimensiones Diámetro de la tubería x Dimensiones de bajante	Cantidad	Código
3" x 3.25" x 2.5" (75mm x 81mm x 62.5mm)	24	0364AAZ
4" x 3.25" x 2.5" (100mm x 81mm x 62.5mm)	24	0464AAZ
4" x 4.25" x 3" (100mm x 106mm x 75mm)	20	0465AAZ
4" x 2.56" x 2.56" (100mm x 63mm x 63mm)	24	0466AAZ
6" x 4" x 6" (150mm x 100mm x 150mm)	1	0664AAZ
6" x 4" x 6" (150mm x 100mm x 150mm)	1	0664AC*



BAJANTES EXPANDIBLES

Dimensiones	Cantidad	Código
2" x 3" (50mm x 75mm)	6	0473AA
3" x 3" (75mm x 75 mm)	6	0474AA

BEND-A-DRAIN™

Dimensiones	Cantidad	Código
4" x 12' (100mm x 3.7 m) Tubo sólido	6	335112
4" x 12' (100mm x 3.7 m) Tubo perforado	6	330112
4" x 25' (100mm x 7.6 m) Tubo sólido	3	335125
4" x 25' (100mm x 7.6 m) Tubo perforado	3	33012533
4" x 25' (100mm x 7.6 m) Tubo perforado con geotextil	3	73258533
4" x 2' (100mm x 0.6 m) Cople sólido de reparación	6	5102

COPE REDUCTOR SNAP*

Dímetros	Cantidad	Código
4" x 3" (100mm x 75mm)	24	0314AAZ
6" x 4" (150mm x 100mm)	9	0614AAZ
8" x 6" (200mm x 150mm)	9	0816AAZ
10" x 8" (250mm x 200mm)	6	1018AAZ
12" x 10" (300mm x 250mm)	1	1210AAZ
15" x 12" (375mm x 300mm)	1	1512AAZ

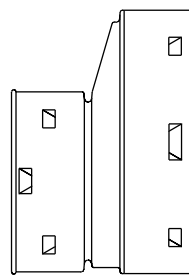

Cople reductor a presión (SNAP)

CODO SNAP A 90°

Dímetros	Cantidad	Código
3" (75mm)	12	0390AAZ
4" (100mm)	10	0490AAZ



Codo a presión (SNAP) a 90°

CODO SNAP A 45°

Dímetros	Cantidad	Código
4" (100mm)	15	0445AAZ



Codo a presión (SNAP) a 45°

-Los coples se venden por separado.

TEE CIEGO

Dímetros	Cantidad	Código
3" (75mm)	12	0341AAZ
4" (100mm)	8	0441AAZ
5" (125mm)	4	0541AAZ
6" (150mm)	3	0641AAZ
8" (200mm)	1	0841AAZ
10" (250mm)	1	1041AAZ

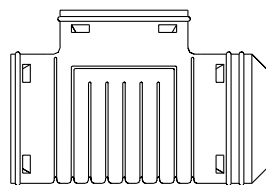

TEE ciego a presión

TEE A PRESIÓN

Dímetros	Cantidad	Código
3" (75mm)	12	0321AAZ
4" (100mm)	8	0421AAZ
5" (125mm)	4	0525AAZ
6" (150mm)	3	0626AAZ

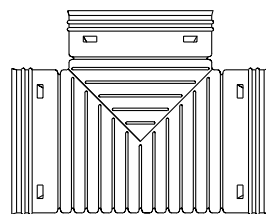

TEE a presión

TEE REDUCTOR

Dímetros (Principal x derivación)	Cantidad	Código
6" x 4" (150mm) x 100mm Red. Tee	3	0624AAZ

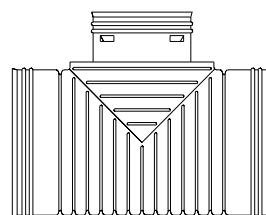

TEE reductor a presión

TEE CIEGO MULTIPLE

Dímetros (Principal x derivación)	Cantidad	Código
8" x 8"/6"/4" (200mm/150mm/100mm)	1	0845AAZ
10" x 10"/8" (250mm/200mm)	1	1045AAZ
12" x 12"/10" (300mm/250mm)	1	1247AAZ
15" x 10" (375mm/250mm)	1	1547AAZ
18" x 12" (450mm/300mm)	1	1847AAZ

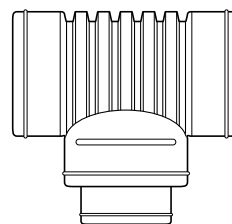

TEE ciego multiple

TEE MULTIPLE

Dímetros (Principal x derivación)	Cantidad	Código
6" x 3"/4"/5"/6" (150mm x 75/100/125/150mm)	3	0644AAZ
8" x 4"/5"/6"/8" (200mm x 100/125/150/200mm)	1	0844AAZ
10" x 6"/8"/10" (250mm x 150/200/250mm)	1	1044AAZ

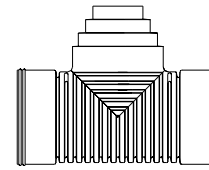

TEE multiple

TEE EN CRUZ MULTIPLE

Dímetros	Cantidad	Código
6" (150mm)	3	0654AAZ

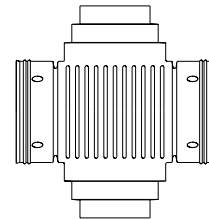

TEE en cruz multiple

DESCARGA LATERAL EN TEE

Dímetros	Cantidad	Código
3" x 6"/8" (75mm x 150mm/200mm)	24	0350AA
4" x 6"/8" (100mm x 150mm/200mm)	24	0450AA
4" x 10"/12" (100mm x 250mm/300mm)	24	0410AA

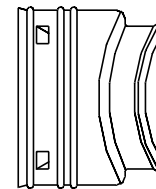

Descarga lateral en TEE

TEE CON BISAGRA

Dímetros	Cantidad	Código
4" (100mm)	12	0421AAHF



TEE con bisagra

-Se adapta a tuberías de pared simple y doble pared.

YEE

Dímetros	Cantidad	Código
3" (75mm)	7	0322AAZ
4" (100mm)	5	0422AAZ
5" (125mm)	4	0522AAZ
6" (150mm)	2	0622AAZ
8" (200mm)	1	0822AAZ



YEE

YEE CON BROCHE INTERNO

Dímetros	Cantidad	Código	Precio
3" (75mm)	12	0322AAIN	\$ 8.31

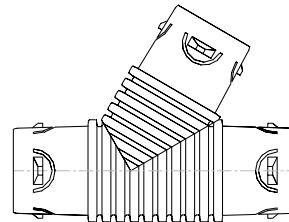

YEE con broche interno

REDUCTOR A TUBO LISO

Descripción	Estilo	Código
8" x 4" excentrico (200mm x 100mm)	perforado	0840AAGF
8" x 4" excentrico (200mm x 100mm)	sin perforar	0839AAZ
10" x 4" excentrico (250mm x 100mm)	perforado	1040AAGF
10" x 4" excentrico (250mm x 100mm)	sin perforar	1039AAZ

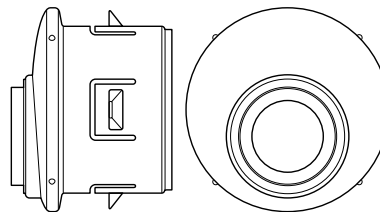

Reductor a tubo de PVC

Turf Flow®

TURF FLOW® DE 2"

Accesorios	Cantidad	Código
Cople	50	0212AA
Tapa	50	0232AA
TEE ciega / Codo	50	0241AA
Reductor	25	0214AA
TEE	50	0221AA

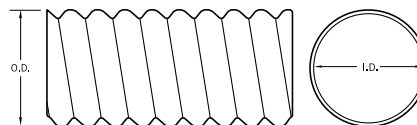

Cople para tubo TurbFlow®

ESTRUCTURAS PARA TRÁNSITO VEHICULAR

Diámetros	Dimensiones	Código
12" (300mm)	2' x 2' (610mm x 610mm)	3212AGS
15" (375mm)	2' x 2' (610mm x 610mm)	3215AGS
18" (450mm)	2' x 2' (610mm x 610mm)	3218AGS
18" (450mm)	2' x 3' (610mm x 914mm)	3218AGR
24" (600mm)	2' x 2' (610mm x 610mm)	3224AGS
24" (600mm)	2' x 3' (610mm x 914mm)	3224AGR
30" (750mm)	2' x 2' (610mm x 610mm)	3230AGS
30" (750mm)	2' x 3' (610mm x 914mm)	3230AGR
36" (900mm)	2' x 2' (610mm x 610mm)	3236AGS
36" (900mm)	2' x 3' (610mm x 914mm)	3236AGR

ESTRUCTURAS PARA TRÁNSITO VEHICULAR

Diámetros	Dimensiones	Código
12" (300mm)	2' x 2' (610mm x 610mm)	3212CGSQFSB
15" (375mm)	2' x 2' (610mm x 610mm)	3215CGSQFSB
18" (450mm)	2' x 2' (610mm x 610mm)	3218CGSQFSB
18" (450mm)	2' x 3' (610mm x 914mm)	3218CGRFSB
24" (600mm)	2' x 2' (610mm x 610mm)	3224CGSQFSB
24" (600mm)	2' x 3' (610mm x 914mm)	3224CGRFSB
30" (750mm)	2' x 2' (610mm x 610mm)	3230CGSQFSB
30" (750mm)	2' x 3' (610mm x 914mm)	3230CGRFSB

- Las estructuras de drenaje para tránsito vehicular se fabrican a la medida para cada proyecto. Se requieren plazos de entrega para surtir el producto, consulte a su distribuidor local.

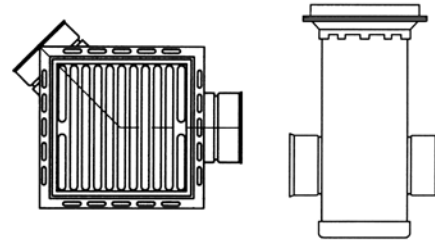

Estructuras de captación con rejillas para banqueteta

ESTRUCTURAS DE CAPTACIÓN

Diámetros	Dimensiones	Código
12" (300mm)	2' x 2' (610mm x 610mm)	3012AGS
15" (375mm)	2' x 2' (610mm x 610mm)	3015AGS
18" (450mm)	2' x 2' (610mm x 610mm)	3018AGS
18" (450mm)	2' x 3' (610mm x 914mm)	3018AGR
24" (600mm)	2' x 2' (610mm x 610mm)	3024AGS
24" (600mm)	2' x 3' (610mm x 914mm)	3024AGR
30" (750mm)	2' x 2' (610mm x 610mm)	3030AGS
30" (750mm)	2' x 3' (610mm x 914mm)	3030AGR
36" (900mm)	2' x 2' (610mm x 610mm)	3036AGS
36" (900mm)	2' x 3' (610mm x 914mm)	3036AGR

- Las estructuras de captación se fabrican a la medida para cada proyecto. Se requieren plazos de entrega para surtir el producto, consulte a su distribuidor local.

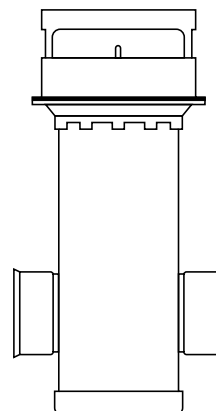
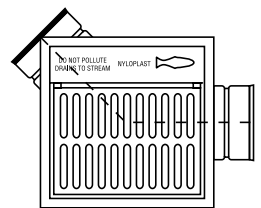

Opciones de rejillas 2' x 2'



Estándar
H-20



Diagonal
H-20

Opciones de rejillas 2' x 3'



Diagonal
H-20



Rejilla de solera inclinada
H-20

ESTRUCTURAS PARA TRÁNSITO PEATONAL

Estructuras	Dimensiones	Código
8" (200mm)	4" (100mm) a 8" (200mm)	2808AG
10" (250mm)	4" (100mm) a 10" (250mm)	2810AG
12" (300mm)	4" (100mm) thru 12" (300mm)	2812AG
15" (375mm)	4" (100mm) thru 15" (375mm)	2815AG
18" (450mm)	4" (100mm) thru 18" (450mm)	2818AG
24" (600mm)	4" (100mm) thru 24" (600mm)	2824AG
30" (750mm)	4" (100mm) thru 30" (750mm)	2830AG
36" (900mm)	4" (100mm) thru 36" (900mm)	2836AG

*Las estructuras de drenaje para tránsito peatonal se fabrican a la medida para cada proyecto. Se requieren plazos de entrega para surtir el producto, consulte a su distribuidor local.

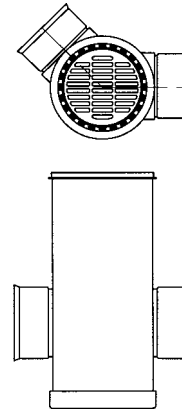

ESTRUCTURAS PARA TRÁNSITO PEATONAL CON SUMIDERO

Estructuras	Dimensiones	Código
24" (600mm)	4" (100mm) thru 24" (600mm)	2824AGWE2
30" (750mm)	4" (100mm) thru 30" (750mm)	830AGWE28
36" (900mm)	4" (100mm) thru 30" (750mm)	36AGWE

-Póngase en contacto con ADS Mexicana para ver alturas mayores de 84" (2134 mm).

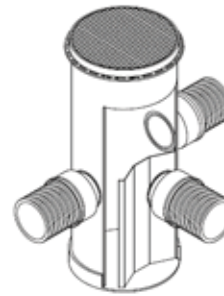

Coladera para estructura de captación

DRENAJE EN LÍNEA

Cuenca	Adaptadores al diámetro del tubo	Código
8" (200mm)	4" (100mm), 6" (150mm), 8" (200mm)	2708AG
10" (250mm)	4" (100mm), 6" (150mm), 8" (200mm), 10" (250mm)	2710AG
12" (300mm)	4" (100mm), 6" (150mm), 8" (200mm), 10" (250mm), 12" (300mm)	2712AG
15" (375mm)	4" (100mm), 6" (150mm), 8" (200mm), 10" (250mm), 12" (300mm), 15" (375mm)	2715AG
18" (450mm)	4" (100mm), 6" (150mm), 8" (200mm), 10" (250mm), 12" (300mm), 15" (375mm), 18" (450mm)	2718AG
24" (600mm)	4" (100mm), 6" (150mm), 8" (200mm), 10" (250mm), 12" (300mm), 15" (375mm), 18" (450mm), 24" (600mm)	2724AG
30" (750mm)	4" (100mm), 6" (150mm), 8" (200mm), 10" (250mm), 12" (300mm), 15" (375mm), 18" (450mm), 24" (600mm), 30" (750mm)	2730AG

-Se requieren plazos de entrega de 3 a 7 días para la entrega del producto.

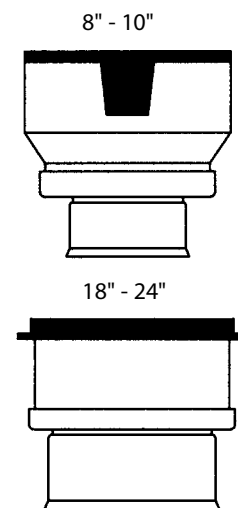

Opciones de rejillas para las estructuras Nyloplast®

Nyloplast® / Rejilla



DOMO - USO LIGERO	
Tamaño	Código
8" (200mm)	0899CGD
10" (250mm)	1099CGD
12" (300mm)	1299CGD
15" (375mm)	1599CGD
18" (450mm)	1899CGD
24" (600mm)	2199CGD



ESTÁNDAR - USO LIGERO	
Tamaño	Código
8" (200mm)	0899CGS
10" (250mm)	1099CGS

BRONCE - USO LIGERO	
Tamaño	Código
8" (200mm)	0899CGB
10" (250mm)	1099CGB

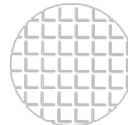

SÓLIDO - USO LIGERO	
Tamaño	Código
8" (200mm)	0899CGC
10" (250mm)	1099CGC

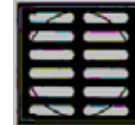

ESTÁNDAR H-20	
Tamaño	Código
12" (300mm)	1299CGS
15" (375mm)*	1599CGS



BRONCE PEATONAL - USO LIGERO	
Tamaño	Código
12" (300mm)	1299CGPB
15" (375mm)*	1599CGPB

Diseño con bisagras.



SÓLIDO H-20	
Tamaño	Código
12" (300mm)	1299CGC
15" (375mm)	1599CGC

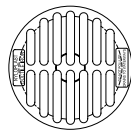

ESTÁNDAR H-20	
Tamaño	Código
18" (450mm)	1899CGS



SÓLIDO H-20	
Tamaño	Código
18" (450mm)	1899CGC
24" (600mm)	2499CGC

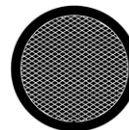

SÓLIDO H-20	
Tamaño	Código
30" (750mm)	3099CGC



ESTÁNDAR H-20	
Tamaño	Código
24" (600mm)	2499CGS

Diseño con bisagras.



ESTÁNDAR H-20	
Tamaño	Código
30" (750mm)	3099CGS



PEATONAL H-10	
Tamaño	Código
18" (450mm)	1899CGP



PEATONAL H-10	
Tamaño	Código
24" (600mm)	2499CGP

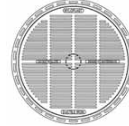

PEATONAL H-20	
Tamaño	Código
30" (750mm)	3099CGP

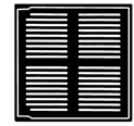

PEATONAL H-10	
Tamaño	Código
12" (300mm)	1299CGP
15" (375mm)	1599CGP

Diseño con bisagras.

(La opción de bloqueo está disponible para la mayoría de las rejillas)

Tapa de rejilla sobrepuesta

TAPA DE REJILLA SOBREPUESTA - USO LIGERO

Tamaño	Código
6" (150mm)	0601DI
8" (200mm)	0801DI
10" (250mm)	1001DI
12" (300mm)	1201DI
15" (375mm)	1501DI
18" (450mm)	1801DI
24" (600mm)	2401DI



Se ajusta dentro de un tubo corrugado ADS

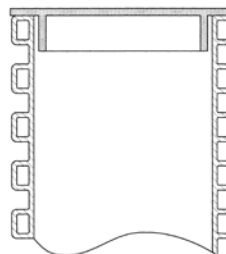

ESTRUCTURA DE CONTROL DE AGUA

Dimensiones	Código
12" (300mm) Diameter Drain Basin	4912AG
15" (375mm) Diameter Drain Basin	4915AG
18" (450mm) Diameter Drain Basin	4918AG
24" (600mm) Diameter Drain Basin	4924AG

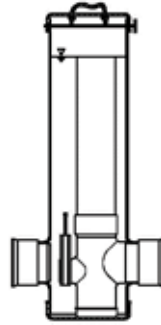

Sumideros

SUMIDEROS

Diametros	Código
12" (300mm)	3812AGSI
15" (375mm)	3815AGSI
18" (450mm)	3818AGSI
24" (600mm)	3824AGSI
30" (750mm)	3830AGSI

Casquillo entrada a estructura

ADD-A-BRANCH™ (Accesorios para instalación)

Tamaños	Adaptadores de estructura	Código
4" (100mm)	Adaptador en estructura de 8"-24" (200-600mm)	6004AG _
4" (100mm)	Adaptador en estructura de 30" (750mm)	6004AG _30
6" (150mm)	Adaptador en estructura de 10"-24" (250-600mm)	6006AG _
6" (150mm)	Adaptador en estructura de 30" (750mm)	6006AG _30
8" (200mm)	Adaptador en estructura de 12"-24" (300-600mm)	6008AG _
8" (200mm)	Adaptador en estructura de 30" (750mm) Structure	6008AG _30
10" (250mm)	Adaptador en estructura de 15"-24" (375-600mm)	6010AG _
10" (250mm)	Adaptador en estructura de 30" (750mm)	6010AG _30
12" (300mm)	Adaptador en estructura de 18" & 24" (450 & 600mm)	6012AG _
12" (300mm)	Adaptador en estructura de 30" (750mm)	6012AG _30
15" (375mm)	Adaptador en estructura de 24" (600mm)	6015AG _
15" (375mm)	Adaptador en estructura de 30" (750mm)	6015AG _30
18" (450mm)	Adaptador en estructura de 30" (750mm)	6018AG _30



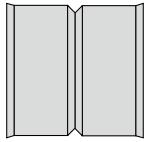

Cople para tubo corrugado

COPLE PARA TUBO CORRUGADO DE DOBLE PARED

Diámetros	Código
4" (100mm)	0471AG
6" (150mm)	0671AG
8" (200mm)	0871AG
10" (250mm)	1071AG
12" (300mm)	1271AG
15" (375mm)	1571AG
18" (450mm)	1871AG
24" (600mm)	2471AG

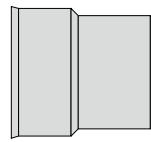

Adapter with SDR 35 spigot

DUAL WALL CORRUGATED ADAPTER WITH SDR 35 SPIGOT

Diámetros	Código
4" (100mm)	0468AG
6" (150mm)	0668AG
8" (200mm)	0868AG
10" (250mm)	1068AG
12" (300mm)	1268AG
15" (375mm)	1568AG
18" (450mm)	1868AG
24" (600mm)	2468AG

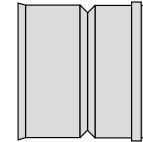

Adapter with SDR 35 bell

DUAL WALL CORRUGATED ADAPTER WITH SDR 35 BELL

Diámetros	Código
4" (100mm)	0469AG
6" (150mm)	0669AG
8" (200mm)	0869AG
10" (250mm)	1069AG
12" (300mm)	1269AG
15" (375mm)	1569AG
18" (450mm)	1869AG
24" (600mm)	2469AG

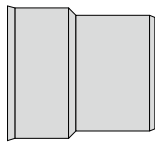

Adapter whit sch 40 spigot

DUAL WALL CORRUGATED ADAPTER WITH SCHEDULE 40 SPIGOT

Diámetros	Código
4" (100mm)	0478AG
6" (150mm)	0678AG
8" (200mm)	0878AG
10" (250mm)	1078AG
12" (300mm)	1278AG
15" (375mm)	1578AG
18" (450mm)	1878AG
24" (600mm)	2478AG

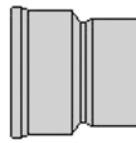

Adapter whit sch 40 bell

DUAL WALL CORRUGATED ADAPTER WITH SCHEDULE 40 BELL

Diámetros	Código
4" (100mm)	0479AG
6" (150mm)	0679AG
8" (200mm)	0879AG
10" (250mm)	1079AG
12" (300mm)	1279AG
15" (375mm)	1579AG
18" (450mm)	1879AG
24" (600mm)	2479AG

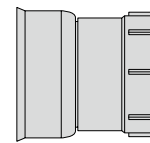

Clean out plug

CLEAN OUT PLUGS

Diámetros	Código
4" (100mm)	0474AG
6" (150mm)	0674AG
8" (200mm)	0874AG
10" (250mm)	1074AG
12" (300mm)	1274AG

COPLE DESLIZABLE PARA REPARACIÓN

Diámetros	Código
4" (100mm)	0475AG
6" (150mm)	0675AG
8" (200mm)	0875AG
10" (250mm)	1075AG
12" (300mm)	1275AG
15" (375mm)	1575AG
18" (450mm)	1875AG
24" (600mm)	2475AG

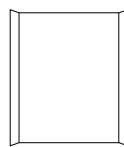

Cople deslizable para reparación

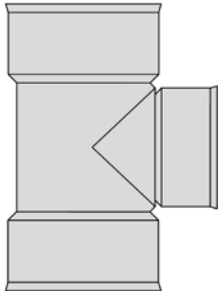

TEE / TEE reductora

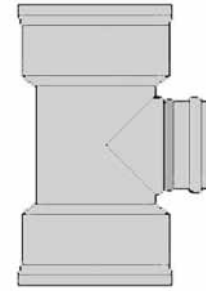

TEE WITH SDR 35 BRANCH

TEE / TEE REDUCTORA PARED DOBLE

Diámetros	Código
10" (250mm) x 4" (100mm)	1081AG
10" (250mm) x 6" (150mm)	1082AG
10" (250mm) x 8" (200mm)	1083AG
10" (250mm) x 10" (250mm)	1084AG
12" (300mm) x 4" (100mm)	1281AG
12" (300mm) x 6" (150mm)	1282AG
12" (300mm) x 8" (200mm)	1283AG
12" (300mm) x 10" (250mm)	1284AG
12" (300mm) x 12" (300mm)	1285AG
15" (375mm) x 4" (100mm)	1581AG
15" (375mm) x 6" (150mm)	1582AG
15" (375mm) x 8" (200mm)	1583AG
15" (375mm) x 10" (250mm)	1584AG
15" (375mm) x 12" (300mm)	1585AG
15" (375mm) x 15" (375mm)	1586AG
18" (450mm) x 4" (100mm)	1881AG
18" (450mm) x 6" (150mm)	1882AG
18" (450mm) x 8" (200mm)	1883AG
18" (450mm) x 10" (250mm)	1884AG
18" (450mm) x 12" (300mm)	1885AG
18" (450mm) x 15" (375mm)	1886AG
18" (450mm) x 18" (450mm)	1887AG
24" (600mm) x 4" (100mm)	2481AG
24" (600mm) x 6" (150mm)	2482AG
24" (600mm) x 8" (200mm)	2483AG
24" (600mm) x 10" (250mm)	2484AG
24" (600mm) x 12" (300mm)	2485AG
24" (600mm) x 15" (375mm)	2486AG
24" (600mm) x 18" (450mm)	2487AG
24" (600mm) x 24" (600mm)	2488AG

DUAL WALL CORRUGATED TEE WHIT SDR 35 BRANCH

Diámetros	Código
10" (250mm) x 4" (100mm)	1061AG
10" (250mm) x 6" (150mm)	1062AG
10" (250mm) x 8" (200mm)	1063AG
10" (250mm) x 10" (250mm)	1064AG
12" (300mm) x 4" (100mm)	1261AG
12" (300mm) x 6" (150mm)	1262AG
12" (300mm) x 8" (200mm)	1263AG
12" (300mm) x 10" (250mm)	1264AG
12" (300mm) x 12" (300mm)	1265AG
15" (375mm) x 4" (100mm)	1561AG
15" (375mm) x 6" (150mm)	1562AG
15" (375mm) x 8" (200mm)	1563AG
15" (375mm) x 10" (250mm)	1564AG
15" (375mm) x 12" (300mm)	1565AG
15" (375mm) x 15" (375mm)	1566AG
18" (450mm) x 4" (100mm)	1861AG
18" (450mm) x 6" (150mm)	1862AG
18" (450mm) x 8" (200mm)	1863AG
18" (450mm) x 10" (250mm)	1864AG
18" (450mm) x 12" (300mm)	1865AG
18" (450mm) x 15" (375mm)	1866AG
18" (450mm) x 18" (450mm)	1867AG
24" (600mm) x 4" (100mm)	2461AG
24" (600mm) x 6" (150mm)	2462AG
24" (600mm) x 8" (200mm)	2463AG
24" (600mm) x 10" (250mm)	2464AG
24" (600mm) x 12" (300mm)	2465AG
24" (600mm) x 15" (375mm)	2466AG
24" (600mm) x 18" (450mm)	2467AG

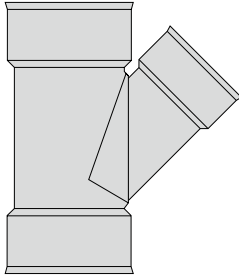

YEE / YEE reductora

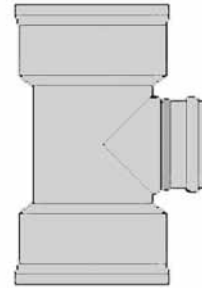

TEE / TEE reductora

YEE / YEE REDUCTORA	
Diámetros	Código
10" (250mm) x 4" (100mm)	1091AG
10" (250mm) x 6" (150mm)	1092AG
10" (250mm) x 8" (200mm)	1093AG
10" (250mm) x 8" (200mm)	1094AG
12" (300mm) x 4" (100mm)	1291AG
12" (300mm) x 6" (150mm)	1292AG
12" (300mm) x 8" (200mm)	1293AG
12" (300mm) x 10" (250mm)	1294AG
12" (300mm) x 12" (300mm)	1295AG
15" (375mm) x 4" (100mm)	1591AG
15" (375mm) x 6" (150mm)	1592AG
15" (375mm) x 8" (200mm)	1593AG
15" (375mm) x 10" (250mm)	1594AG
15" (375mm) x 12" (300mm)	1595AG
15" (375mm) x 15" (375mm)	1596AG
18" (450mm) x 4" (100mm)	1891AG
18" (450mm) x 6" (150mm)	1892AG
18" (450mm) x 8" (200mm)	1893AG
18" (450mm) x 10" (250mm)	1894AG
18" (450mm) x 12" (300mm)	1895AG
18" (450mm) x 15" (375mm)	1896AG
18" (450mm) x 18" (450mm)	1897AG
24" (600mm) x 4" (100mm)	2491AG
24" (600mm) x 6" (150mm)	2492AG
24" (600mm) x 8" (200mm)	2493AG
24" (600mm) x 10" (250mm)	2494AG
24" (600mm) x 12" (300mm)	2495AG
24" (600mm) x 15" (375mm)	2496AG
24" (600mm) x 18" (450mm)	2497AG
24" (600mm) x 24" (600mm)	2498AG

YEE / YEE REDUCTORA	
Diámetros	Código
10" (250mm) x 4" (100mm)	1061AG
10" (250mm) x 6" (150mm)	1062AG
10" (250mm) x 8" (200mm)	1063AG
10" (250mm) x 8" (200mm)	1064AG
12" (300mm) x 4" (100mm)	1261AG
12" (300mm) x 6" (150mm)	1262AG
12" (300mm) x 8" (200mm)	1263AG
12" (300mm) x 10" (250mm)	1264AG
12" (300mm) x 12" (300mm)	1265AG
15" (375mm) x 4" (100mm)	1561AG
15" (375mm) x 6" (150mm)	1562AG
15" (375mm) x 8" (200mm)	1563AG
15" (375mm) x 8" (200mm)	1564AG
15" (375mm) x 10" (250mm)	1565AG
15" (375mm) x 12" (300mm)	1566AG
15" (375mm) x 15" (375mm)	1566AG
18" (450mm) x 4" (100mm)	1861AG
18" (450mm) x 6" (150mm)	1862AG
18" (450mm) x 8" (200mm)	1863AG
18" (450mm) x 10" (250mm)	1864AG
18" (450mm) x 12" (300mm)	1865AG
18" (450mm) x 15" (375mm)	1866AG
18" (450mm) x 18" (450mm)	1867AG
24" (600mm) x 4" (100mm)	2461AG
24" (600mm) x 6" (150mm)	2462AG
24" (600mm) x 8" (200mm)	2463AG
24" (600mm) x 10" (250mm)	2464AG
24" (600mm) x 12" (300mm)	2465AG
24" (600mm) x 15" (375mm)	2466AG
24" (600mm) x 18" (450mm)	2467AG

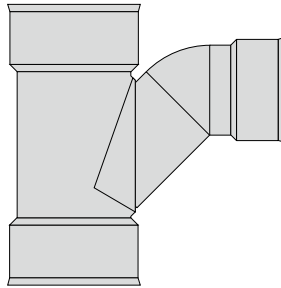

TEE Barrida

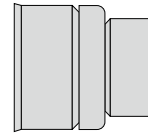

Reductor concéntrico

TEE BARRIDA	
Diámetros	Código
4" (100mm) x 4" (100mm)	0435AG
6" (150mm) x 4" (100mm)	0635AG
6" (150mm) x 6" (150mm)	0636AG
8" (200mm) x 4" (100mm)	0835AG
8" (200mm) x 6" (150mm)	0836AG
8" (2000mm) x 8" (200mm)	0837AG
10" (250mm) x 4" (100mm)	1035AG
10" (250mm) x 6" (150mm)	1036AG
10" (250mm) x 8" (200mm)	1037AG
12" (300mm) x 4" (100mm)	1235AG
12" (300mm) x 6" (150mm)	1236AG
12" (300mm) x 8" (200mm)	1237AG
15" (375mm) x 4" (100mm)	1535AG
15" (375mm) x 6" (150mm)	1536AG
15" (375mm) x 8" (200mm)	1537AG
18" (450mm) x 4" (100mm)	1835AG
18" (450mm) x 6" (150mm)	1836AG
18" (450mm) x 8" (200mm)	1837AG
24" (600mm) x 4" (100mm)	2435AG
24" (600mm) x 6" (150mm)	2436AG
24" (600mm) x 8" (200mm)	2437AG

REDUCTOR CONCÉNTRICO	
Diámetros	Código
6" (150mm) x 4" (100mm)	0611AG
8" (200mm) x 4" (100mm)	0811AG
8" (2000mm) x 8" (200mm)	0812AG
10" (250mm) x 4" (100mm)	1011AG
10" (250mm) x 6" (150mm)	1012AG
10" (250mm) x 8" (200mm)	1013AG
12" (300mm) x 4" (100mm)	1211AG
12" (300mm) x 6" (150mm)	1212AG
12" (300mm) x 8" (200mm)	1213AG
12" (300mm) x 10" (250mm)	1214AG
15" (375mm) x 4" (100mm)	1511AG
15" (375mm) x 6" (150mm)	1512AG
15" (375mm) x 8" (200mm)	1513AG
15" (375mm) x 10" (250mm)	1514AG
15" (375mm) x 12" (300mm)	1515AG
18" (450mm) x 4" (100mm)	1811AG
18" (450mm) x 6" (150mm)	1812AG
18" (450mm) x 8" (200mm)	1813AG
18" (450mm) x 10" (250mm)	1814AG
18" (450mm) x 12" (300mm)	1815AG
18" (450mm) x 15" (375mm)	1816AG
24" (600mm) x 4" (100mm)	2411AG
24" (600mm) x 6" (150mm)	2412AG
24" (600mm) x 8" (200mm)	2413AG
24" (600mm) x 10" (250mm)	2414AG
24" (600mm) x 12" (300mm)	2415AG
24" (600mm) x 15" (375mm)	2416AG
24" (600mm) x 18" (450mm)	2417AG

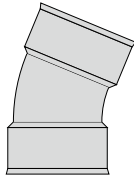

Codo a 22.5°

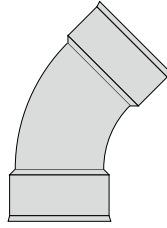

Codo a 45°

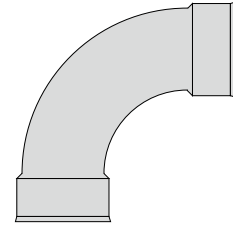

Codo a 90°

CODO A 22.5°

Diámetros	Código
4" (100mm)	0422AG
6" (150mm)	0622AG
8" (200mm)	0822AG
10" (250mm)	1022AG
12" (300mm)	1222AG
15" (375mm)	1522AG
18" (450mm)	1822AG
24" (600mm)	2422AG

CODO A 45°

Diámetros	Código
10" (250mm)	1045AG
12" (300mm)	1245AG
15" (375mm)	1545AG
18" (450mm)	1845AG
24" (600mm)	2445AG

CODO A 90°

Diámetros	Código
10" (250mm)	1090AG
12" (300mm)	1290AG
15" (375mm)	1590AG
18" (450mm)	1890AG
24" (600mm)	2490AG

Tapa

Tapa de registro

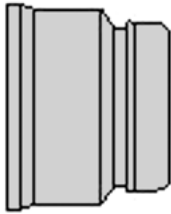

Tapa

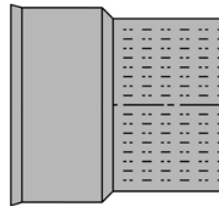

Tapa de registro

TAPA PARA NYLOPLAST®

Diámetros	Código
4" (100mm)	0432AG
6" (150mm)	0632AG
8" (200mm)	0832AG
10" (250mm)	1032AG
12" (300mm)	1232AG
15" (375mm)	1532AG
18" (450mm)	1832AG
24" (600mm)	2432AG

TAPA DE REGISTRO PARA NYLOPLAST®

Diámetros	Código
4" (100mm)	0477AG
6" (150mm)	0677AG
8" (200mm)	0877AG
10" (250mm)	1077AG
12" (300mm)	1277AG
15" (375mm)	1577AG
18" (450mm)	1877AG
24" (600mm)	2477AG

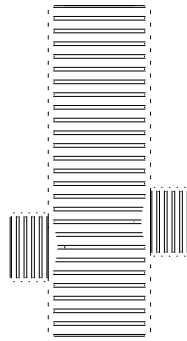

Registro pluvial

REGISTRO PLUVIAL* Hecho a la medida solo para ordenar

Diámetro del registro	Altura	Diámetro de derivación
12" - 36" (300mm-900mm)	2' - 8' (0.6m-2.4m)	4" - 30" (100mm-750mm)

- Los registros pluviales deben estar correctamente rellenados verticalmente según el manual de instalación. Utilice la hoja de limitación de ajuste para informar y garantizar el correcto cumplimiento de la instalación. El tubo de PEAD de 1050 a 1500 mm (42" a 60") no está disponible para aplicaciones verticales.

Las derivaciones deben encajar en la circunferencia del registro y no deben estar superpuestas. Las derivaciones son de longitud estándar para el acoplamiento y deben tener un diámetro más pequeño que el tubo ascendente. No se pueden colocar más de tres derivaciones por estructura en la mayoría de las circunstancias.

Las tapas deben instalarse según el detalle para registros de uso ligero y están disponibles a través de otros fabricantes. La altura del fondo del registro no viene de serie, debe ser solicitada de acuerdo al proyecto. La derivaciones se deben de especificar con campana o espiga.

Las tapas de los extremos son solo para aplicaciones horizontales. No se permite el uso de tapas finales en ninguna aplicación vertical. El uso indebido o la falla de asegurar las tapas de los extremos puede causar daños a personas o propiedades o lesiones o la muerte.



Pozo de visita pluvial

POZO DE VISITA PLUVIAL** Hecho a la medida solo para ordenar

Diámetro del pozo	Altura	Diámetro de derivación
48" (1200mm)	2' - 8' (0.6m-2.4m)	4" - 30" (100mm-750mm)

- Los pozos de visita pluviales deben estar correctamente rellenados verticalmente según el manual de instalación. Utilice la hoja de limitación de ajuste para informar y garantizar el correcto cumplimiento de la instalación.

Las derivaciones deben encajar en la circunferencia del registro y no deben estar superpuestas. Las derivaciones son de longitud estándar para el acoplamiento y deben tener un diámetro más pequeño que el tubo ascendente. No se pueden colocar más de tres derivaciones por estructura en la mayoría de las circunstancias.

Las tapas deben instalarse según el detalle para registros de uso ligero y están disponibles a través de otros fabricantes. La altura del fondo del registro no viene de serie, debe ser solicitada de acuerdo al proyecto. La derivaciones se deben de especificar con campana o espiga.

Las tapas de los extremos son solo para aplicaciones horizontales. No se permite el uso de tapas finales en ninguna aplicación vertical. El uso indebido o la falla de asegurar las tapas de los extremos puede causar daños a personas o propiedades o lesiones o la muerte.

ELEVADORES HICKENBOTTOM®		
Diámetros	Descripción	Código
5" (125mm) x 1" (25mm)	Orange Intake (12 Holes)	5013GC
5" (125mm) x 1" (25mm)	Orange Riser with Cap-Top	5023GC
5" (125mm) x 5/16" (8mm)	Orange Ext-Btm	5033GC
5" (125mm)	Blind Tee	5043GC
5" (125mm)	Restrictor	5063GC
6" (150mm) x 1" (25mm)	Orange Riser with Cap-Top	6023GC
6" (150mm) x 5/16" (8mm)	Orange Ext-Btm	6033GC
6" (150mm)	Black Slotted Intake	6073GC
6" (150mm)	Black Blank Section	6053GC
6" (150mm)	Black Riser Blind Tee	6043GC
6" (150mm)	Restrictor	6063GC
8" (200mm) x 1" (25mm)	Orange Riser with Cap-Top	0823GC
8" (200mm) x 5/16" (8mm)	Orange Ext-Btm	0833GC
8" (200mm)	Black Slotted IntakeBlack	0873GC
8" (200mm)	Blank Section	0853GC
8" (200mm)	Black Riser Blind Tee	0843GC
8" (200mm)	Restrictor	0863GC
10" (250mm) x 1" (25mm)	Orange Riser with Cap-Top	1023GC
10" (250mm) x 5/16" (8mm)	Orange Ext-Btm	1033GC
10" (250mm)	Black Slotted Intake	1073GC
10" (250mm)	Black Blank Section	1053GC
10" (250mm)	Black Riser Blind Tee	1043GC
12" (300mm) x 1" (25mm)	Orange Riser with Cap-Top	1223GC
12" (300mm) x 5/16" (8mm)	Orange Ext-BtmBlack Slotted	1233GC
12" (300mm)	Intake	1273GC
12" (300mm)	Black Blind Tee	1243GC



HICKENBOTTOM RISER



HICKENBOTTOM RESTRICTOR

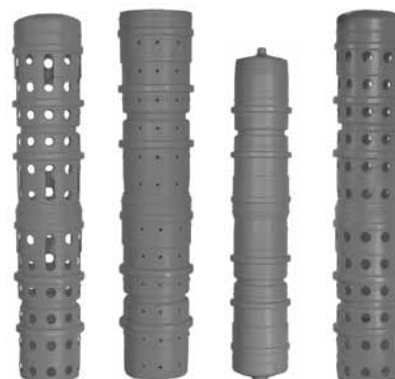

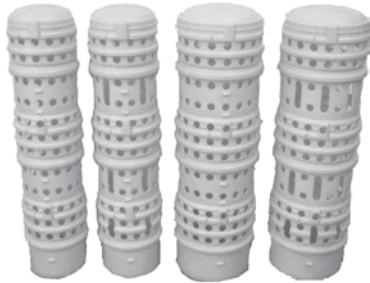

TOMAS DE PRECISIÓN

Diámetros	Descripción	Código
6" x 1" (150 x 25 mm)	Yellow Riser with Cap-Top	6023GKY
6" x 5/16" (150 x 8 mm)	Yellow Ext-Btm	6033GKY
6" (150 mm)	Black Slotted Intake	6073GKY
6" (150 mm)	Black Blank Section	6053GKY
6" (150 mm)	Black Riser Blind Tee	6043GKY
6" (150 mm)	Restrictor	6063GKY
8" x 1" (200 x 25 mm)	Yellow Riser with Cap-Top	0823GKY
8" x 5/16" (200 x 8 mm)	Yellow Ext-Btm	0833GKY
8" (200 mm)	Black Slotted Intake	0873GKY
8" (200 mm)	Black Blank Section	0853GKY
8" (200 mm)	Black Riser Blind Tee	0843GKY
8" (200 mm)	Restrictor	0863GKY
10" x 1" (250 x 25 mm)	Yellow Riser with Cap-Top	1023GKY
10" x 5/16" (250 x 8 mm)	Yellow Ext-Btm	1033GKY
10" (250 mm)	Black Slotted Intake	1073GKY
10" (250 mm)	Black Blank Section	1053GKY
10" (250 mm)	Black Riser Blind Tee	1043GKY



QUICK DRAIN
RISER



ADJUSTABLE
INLET

ELEVADORES DE DRENAJE RÁPIDO

Diámetros	Código
6" Diameter x 6" Inlet (150 x 150 mm)	0606QD
10" Diameter x 6" Inlet (250 x 150 mm)	1006QD
10" Diameter x 8" Inlet (250 x 200 mm)	1008QD
6" Diameter x 6" Inlet (150 x 150 mm) with Adjustable Inlet	0606TPTQD

Cabezales plasticos para alcantarillas

Accesorios - Outflow Accessories

Vista superior

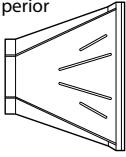

Vista lateral

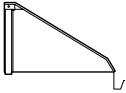

Vista frontal



Terminación acampanada

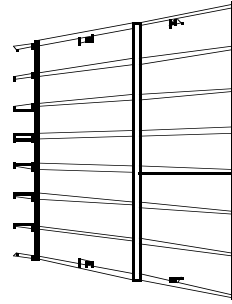

Protección metálica para basura

TERMINACIÓN ACAMPANADA

Diámetros	Código
10" (250mm)	1015NP
12" (300mm) / 15" (375mm)	1215NP
18" (450mm)	1810NP
24" (600mm)	2410NP
30" (750mm)	3015NP
36" (900mm)	3615NP

PROTECCIÓN METÁLICA PARA BASURA*

Diámetros	Descripción	Código
12" (300mm)	Acero galvanizado	1290DA
15" (375mm)	Acero galvanizado	1590DA
18" (450mm)	Acero galvanizado	1890DA
24" (600mm)	Acero galvanizado	2490DA
30" (750mm)	Acero galvanizado	3090DA
36" (900mm)	Acero galvanizado	3690DA

-La rejilla se dimensiona para ajustarse unicamente en terminaciones acampanadas.

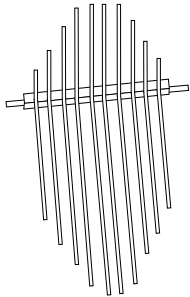

Protección para fauna (Rejilla)

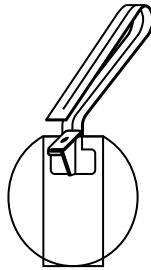

Protección para fauna (Sólido)

PROTECCIÓN PARA FAUNA

Diámetros	Descripción	Código
4" (100mm)	protección metálica (rejilla)	0470DA
	protección sólida	0471DA
6" (150mm)	protección metálica (rejilla)	0670DA
	protección sólida	0671DA
8" (200mm)	protección metálica (rejilla)	0870DA
	protección sólida	0871DA
10" (250mm)	protección metálica (rejilla)	1070DA
	protección sólida	1071DA
12" (300mm)	protección metálica (rejilla)	1270DA
15" (375mm)	protección metálica (rejilla)	1570DA
18" (450mm)	protección metálica (rejilla)	1870DA
24" (600mm)	protección metálica (rejilla)	2470DA
30" (750mm)	protección metálica (rejilla)	3070DA
36" (900mm)	protección metálica (rejilla)	3670DA

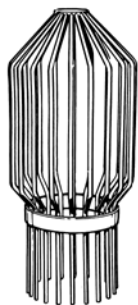

Protector de barra



Compuerta de solapa

PROTECTORES DE BARRA

Diámetros	Código
4" (100mm)	0420DA
6" (150mm)	0620DA
8" (200mm)	0820DA
10" (250mm)	1020DA
12" (300mm)	1220DA
15" (375mm)	1520DA
18" (450mm)	1820DA
24" (600mm)	2420DA
30" (750mm)	3020DA
36" (900mm)	3620DA

COMPUERTA DE SOLAPA

Diámetros	Código
4" (100mm)	0440DA
6" (150mm)	0640DA
8" (200mm)	0840DA
10" (250mm)	1040DA
12" (300mm)	1240DA
15" (375mm)	1540DA
18" (450mm)	1840DA
24" (600mm)	2440DA
30" (750mm)	3040DA
36" (900mm)	3640DA

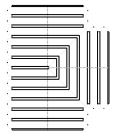

espiga - espiga sencilla

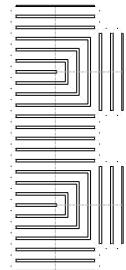

espiga - espiga doble

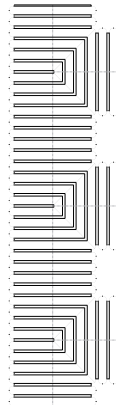

espiga - espiga triple

DISTRIBUIDORES CON DERIVACIONES SEMEJANTES

Diámetros	Distribuidores con terminación en espiga - espiga		
	sencilla	Doble	Triple
12" (300mm)	1251AN	1252AN	1253AN
15" (375mm)	1551AN	1552AN	1553AN
18" (450mm)	1851AN	1852AN	1853AN
24" (600mm)	2451AN	2452AN	2453AN
30" (750mm)	3051AN	3052AN	3053AN
36" (900mm)	3651AN	3652AN	3653AN
42" (1050mm)	4251AN	4252AN	
48" (1200mm)	4851AN	4852AN	
60" (1500mm)	6051AN	6052AN	

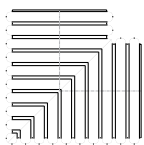

Codo espiga - espiga

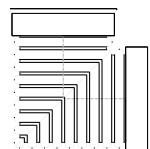

Codo campana - campana

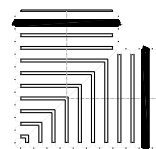

Codo con empaque espiga - espiga

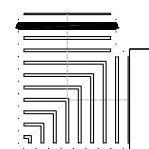

Codo con empaque campana - espiga

CODOS PARA DISTRIBUIDORES A 90°

Diámetros	Codo espiga - espiga	Codo campana - campana	Codo con empaque espiga - espiga	Codo con empaque campana - espiga
12" (300mm)	1298AN	1298AN65BB	1298AN65GG	1298AN65BBG
15" (375mm)	1598AN	1598AN65BB	1598AN65GG	1598AN65BBG
18" (450mm)	1898AN	1898AN65BB	1898AN65GG	1898AN65BBG
24" (600mm)	2498AN	2498AN65BB	2498AN65GG	2498AN65BBG
30" (750mm)	3098AN	3098AN65BB	3098AN65GG	3098AN65BBG
36" (900mm)	3698AN	3698AN65BB	3698AN65GG	3698AN65BBG
42" (1050mm)	4298AN	4298AN65BB	4298AN65GG	4298AN65BBG
48" (1200mm)	4898AN	4898AN65BB	4898AN65GG	4898AN65BBG
60" (1500mm)	6098AN	6098AN65BB	6098AN65GG	6098AN65BBG

-Solo para sistemas de retención

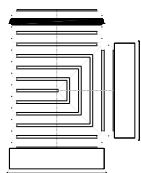

campana - espiga sencilla

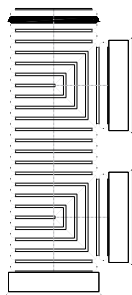

campana - espiga doble

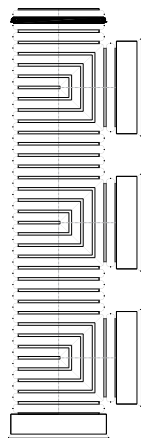

campana - espiga triple

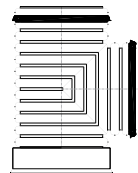

campana - espiga sencilla

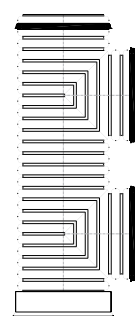

campana - espiga doble

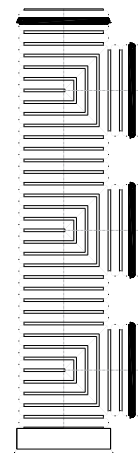

campana - espiga triple

DISTRIBUIDORES CON DERIVACIONES SEMEJANTES

Diámetros	Distribuidores con terminación en campana - espiga			Distribuidores con terminación en campana - espiga con empaque		
	Sencilla	Doble	Triple	Sencilla	Doble	Triple
12" (300mm)	1251AN65B	1252AN65B	1253AN65B	1251AN65G	1252AN65G	1253AN65G
15" (375mm)	1551AN65B	1552AN65B	1553AN65B	1551AN65G	1552AN65G	1553AN65G
18" (450mm)	1851AN65B	1852AN65B	1853AN65B	1851AN65G	1852AN65G	1853AN65G
24" (600mm)	2451AN65B	2452AN65B	2453AN65B	2451AN65G	2452AN65G	2453AN65G
30" (750mm)	3051AN65B	3052AN65B	3053AN65B	3051AN65G	3052AN65G	3053AN65G
36" (900mm)	3651AN65B	3652AN65B	3653AN65B	3651AN65G	3652AN65G	3653AN65G
42" (1050mm)	4251AN65B	4252AN65B		4251AN65G	4252AN65G	
48" (1200mm)	4851AN65B	4852AN65B		4851AN65G	4852AN65G	
60" (1500mm)	6051AN65B	6052AN65B		6051AN65G	6052AN65G	

-Solo para sistemas de retención

PUERTO DE ENTRADA PARED DOBLE

Dímetros	Código
4" (100mm)	0403AN
6" (150mm)	0603AN
8" (200mm)	0803AN
10" (250mm)	1003AN
12" (300mm)	1203AN
15" (375mm)	1503AN
18" (450mm)	1803AN
24" (600mm)	2403AN

Este accesorio puede ser ordenado con medidas estándar o medidas de catálogo. Cuando ordene este accesorio asegurarse que este incluido el dibujo con la localización de la entrada al sistema. Contacta con tu representante de ventas para información acerca de la combinación de diámetros disponibles; por ejemplo: para un tubo de 48 plg de diámetro se puede tener un puerto de 24 plg. No todas las combinaciones son posibles.

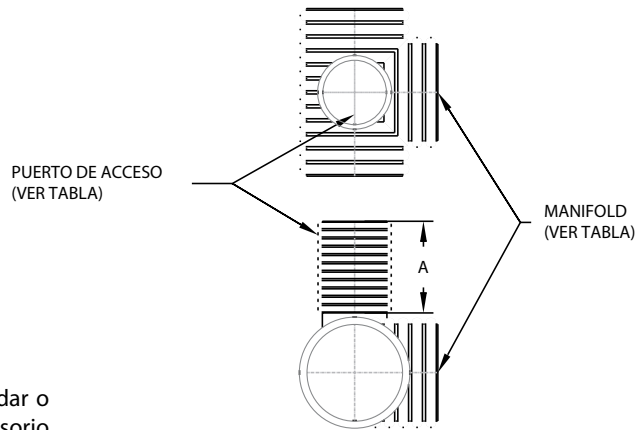

PUERTO DE LIMPIEZA PARED DOBLE

Dímetros	Código
4" (100mm)	0402AN
6" (150mm)	0602AN
8" (200mm)	0802AN

Este accesorio puede ser ordenado con medidas estándar o medidas de catálogo. Cuando ordene este accesorio asegurarse que este incluido el dibujo con la localización de la entrada al sistema.

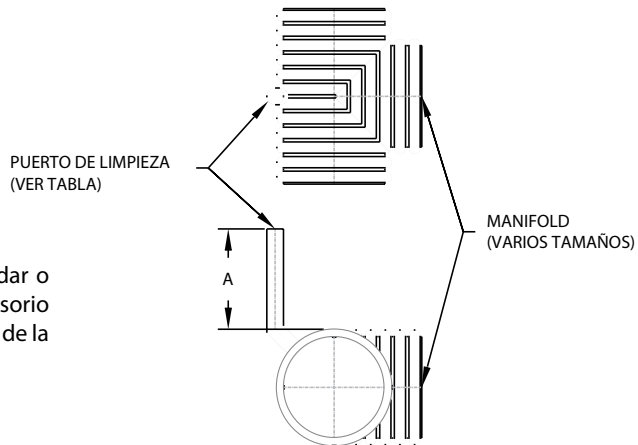

PLACA FINAL SOLDADA (ST/WT CONNECTION)

Dímetros	Código
4" (100mm)	0409AN
6" (150mm)	0609AN
8" (200mm)	0809AN
10" (250mm)	1009AN
12" (300mm)	1209AN
15" (375mm)	1509AN
18" (450mm)	1809AN
24" (600mm)	2409AN
30" (750mm)	3009AN
36" (900mm)	3609AN
42" (1050mm)	4209AN
48" (1200mm)	4809AN
60" (1500mm)	6009AN

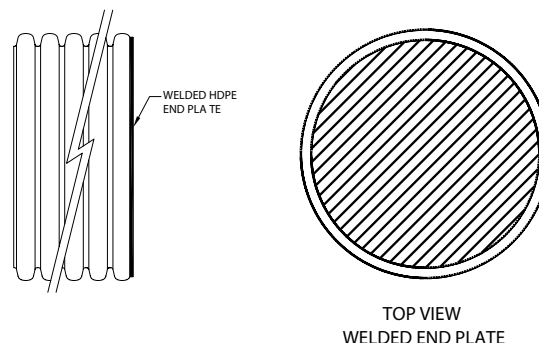

SALIDA AUXILIAR PARED DOBLE

Dímetros	Código
4" (100mm)	0406AN
6" (150mm)	0606AN
8" (200mm)	0806AN
10" (250mm)	1006AN
12" (300mm)	1206AN
15" (375mm)	1506AN
18" (450mm)	1806AN
24" (600mm)	2406AN

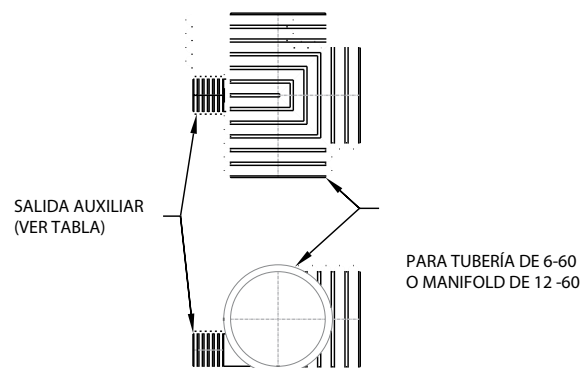

Este accesorio puede ser ordenado con medidas estandar o medidas de catalogo. Cuando ordene este accesorio asegurarse que este incluido el dibujo con la localizacion de la entrada al sistema.

Contacta con tu representante de ventas para información acerca de la combinación de diámetros disponibles; por ejemplo: para un tubo de 48 plg de diametro se puede tener una salida auxiliar de 24 plg. No todas las combinaciones son posibles.



MC-4500

MC-3500

DC-780

SC-740

SC-310

SC-160LP

MODELO SC-160

Dimensiones Largo x Ancho x Altura	Capacidad nominal	Capacidad de almacenamiento	Almacenamiento instalado	Código
85.4" (2169mm) x 25" (635mm) x 12" (305mm)	24 lbs. (10.9kg)	6.85 ft ³ (0.19m ³)	15.0 ft ³ (0.42m ³)	SC160

MODELO SC-310

Dimensiones Largo x Ancho x Altura	Capacidad nominal	Capacidad de almacenamiento	Almacenamiento instalado	Código
85.4" (2169mm) x 34" (864mm) x 16" (406mm)	35 lbs. (15.9kg)	14.7 ft ³ (0.42m ³)	31.0 ft ³ (0.88m ³)	SC310

MODELO SC-740

Dimensiones Largo x Ancho x Altura	Capacidad nominal	Capacidad de almacenamiento	Almacenamiento instalado	Código
85.4" (2169mm) x 51" (1295mm) x 30" (762mm)	75 lbs. (34.1kg)	45.9 ft ³ (1.30m ³)	74.9 ft ³ (2.12m ³)	SC740

MODELO DC-780

Dimensiones Largo x Ancho x Altura	Capacidad nominal	Capacidad de almacenamiento	Almacenamiento instalado	Código
85.4" (2169mm) x 51" (1295mm) x 30" (762mm)	80 lbs. (36.3kg)	46.2 ft ³ (1.30m ³)	78.4 ft ³ (2.20m ³)	DC780

MODELO MC-3500

Dimensiones Largo x Ancho x Altura	Capacidad nominal	Capacidad de almacenamiento	Almacenamiento instalado	Código
86.0" (2184mm) x 77" (1956mm) x 45" (1143mm)	135 lbs. (61.2kg)	109.9 ft ³ (3.11m ³)	178.9 ft ³ (5.06m ³)	MC3500

MODELO MC-4500

Dimensiones Largo x Ancho x Altura	Capacidad nominal	Capacidad de almacenamiento	Almacenamiento instalado	Código
52" (1321mm) x 100" (2540mm) x 60" (1524mm)	130 lbs. (59.0kg)	106.5 ft ³ (3.01m ³)	162.6 ft ³ (4.60m ³)	MC4500



Tapa para SC-160LP



Tapa para SC-310 y SC-740



Tapa para DC-780



Tapa para MC-3500



Tapa para MC-4500

MODELO SC-160LP

Dimensiones Largo x Ancho x Altura	Peso nominal	Código
4.4" (112mm) x 18.6" (472mm) x 11.7" (297mm)	2 lbs. (0.6kg)	SC160IEPP

MODELO SC-310

Dimensiones Largo x Ancho x Altura	Peso nominal	Código
9.9" (252mm) x 29" (737mm) x 15.6" (396 mm)	4 lbs. (1.8kg)	SC310EPE

MODELO SC-740

Dimensiones Largo x Ancho x Altura	Peso nominal	Código
12.2 (310mm) x 45.9" (1166mm) x 29.3" (744 mm)	13 lbs. (5.9kg)	SC740EPE

MODELO DC-780

Dimensiones Largo x Ancho x Altura	Peso nominal	Código
12.2 (310mm) x 45.9" (1166mm) x 29.3" (744mm)	13 lbs. (5.9kg)	SC740EPE

MODELO MC-3500

Dimensiones Largo x Ancho x Altura	Peso nominal	Capacidad de almacenamiento	Almacenamiento instalado*	Código
25.7" (653mm) x 77" (1956mm) x 45.0" (1143 mm)	50 lbs. (22.7kg)	14.9 ft³ (0.42m³)	46.0 ft³ (1.30m³)	MC3500IEPP

MODELO MC-4500

Dimensiones Largo x Ancho x Altura	Peso nominal	Capacidad de almacenamiento	Almacenamiento instalado*	Código
35.1" (892mm) x 90.2" (2291mm) x 59.4" (1509mm)	135 lbs. (61.2kg)	35.7 ft³ (1.01m³)	108.7 ft³ (3.08m³)	MC4500REPE



Tapa con entrada superior



Tapa con entrada inferior

TAPA CON ENTRADA SUPERIOR

Modelo	Diámetros	Código
SC-310	6" (150mm) PEAD	SC310EPE06T
SC-740	6" (150mm) PEAD	SC740EPE06T
DC-780	12" (300mm) PEAD	SC740EPE12T
	15" (375mm) PEAD	SC740EPE15T
	18" (450mm) PEAD	SC740EPE18T
MC-3500	6" (150mm) PEAD	MC3500IEPP06T
	8" (200mm) PEAD	MC3500IEPP08T
	10" (250mm) PEAD	MC3500IEPP10T
	12" (300mm) PEAD	MC3500IEPP12T
	15" (375mm) PEAD	MC3500IEPP15T
	18" (450mm) PEAD	MC3500IEPP18T
MC-4500	24" (600mm) PEAD	MC3500IEPP24T
	12" (300mm) PEAD	MC4500REPE12T
	15" (375mm) PEAD	MC4500REPE15T
	18" (450mm) PEAD	MC4500REPE18T
	24" (600mm) PEAD	MC4500REPE24T

TAPA CON ENTRADA INFERIOR

Modelo	Diámetros	Código	
SC-310	6" (150mm) PEAD	SC310EPE06B	
	8" (200mm) PEAD	SC310EPE08B	
	10" (250mm) PEAD	SC310EPE10B	
	12" (300mm) PEAD	SC310EPE12B	
SC-740	6" (150mm) PEAD	SC740EPE06B	
DC-780	8" (200mm) PEAD	SC740EPE08B	
	10" (250mm) PEAD	SC740EPE10B	
	12" (300mm) PEAD	SC740EPE12B	
	15" (375mm) PEAD	SC740EPE15B	
	18" (450mm) PEAD	SC740EPE18B	
	24" (600mm) PEAD	SC740EPE24B	
MC-3500	6" (150mm) PEAD	MC3500IEPP06B	
	8" (200mm) PEAD	MC3500IEPP08B	
	10" (300mm) PEAD	MC3500IEPP10B	
	12" (300mm) PEAD	MC3500IEPP12B	
	15" (375mm) PEAD	MC3500IEPP15B	
	18" (450mm) PEAD	MC3500IEPP18B	
	24" (375mm) PEAD	MC3500IEPP24B	
	30" (450mm) PEAD	MC3500IEPP30B	
	MC-4500	12" (300mm) PEAD	MC4500REPE12B
		15" (375mm) PEAD	MC4500REPE15B
18" (300mm) PEAD		MC4500REPE18B	
24" (600mm) PEAD		MC4500REPE24B	
30" (750mm) PEAD		MC4500REPE30B	
36" (600mm) PEAD		MC4500REPE36B	
42" (750mm) PEAD		MC4500REPE42B	

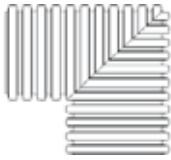

Codo para SC-310

CODO PARA SC-310

Diámetros	Código
6" (150mm)	0698AN31
8" (200mm)	0898AN31
10" (250mm)	1098AN31
12" (300mm)	1298AN31

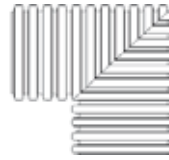

Codo para SC-310

CODO PARA SC-310

Diámetros	Código
8" (200mm)	0898AN74
10" (250mm)	1098AN74
12" (300mm)	1298AN74
15" (375mm)	1598AN74
18" (450mm)	1898AN74
24" (600mm)	2498AN74

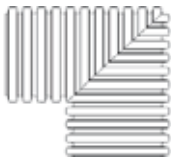

Codo para MC-3500

CODO PARA MC-3500

Diámetros	Código
12" (300mm)	1298AN3512
15" (375mm)	1598AN3515
18" (450mm)	1898AN3518
24" (600mm)	2498AN3524

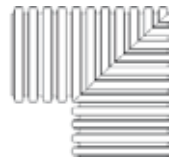

Codo para MC-4500

CODO PARA MC-4500

Diámetros	Código
12" (300mm)	1298AN4512
15" (375mm)	1598AN4515
18" (450mm)	1898AN4518
24" (600mm)	2498AN4524

TEE SENCILLO PARA SC-310

Diámetros	Código
6" x 6" (150mm x 150mm) Tee	0651AN3106
8" x 8" (200mm x 200mm) Tee	0851AN3108
10" x 10" (250mm x 250mm) Tee	1051AN3110
12" x 12" (300mm x 300mm) Tee	1251AN3112

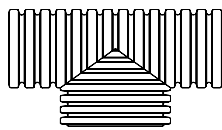

Colector sencillo

TEE SENCILLO PARA SC-740/DC-780

Diámetros	Código
6" x 6" (150mm x 150mm) Tee	0651AN7406
8" x 8" (200mm x 200mm) Tee	0851AN7408
10" x 10" (250mm x 250mm) Tee	1051AN7410
12" x 12" (300mm x 300mm) Tee	1251AN7412
15" x 15" (375mm x 375mm) Tee	1551AN7415
18" x 18" (450mm x 450mm) Tee	1851AN7418
24" x 24" (600mm x 600mm) Tee	2451AN7424

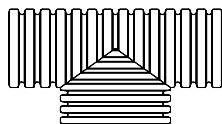

Colector sencillo

TEE SENCILLO PARA MC-3500

Diámetros	Código
12" x 12" (300mm x 300mm) Tee	1251AN35121
15" x 15" (375mm x 375mm) Tee	551AN351518
18" x 18" (450mm x 450mm) Tee	51AN3518245
24" x 24" (600mm x 600mm) Tee	1AN3524

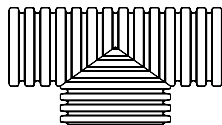

Colector sencillo

TEE SENCILLO PARA MC-4500

Diámetros	Código
12" x 12" (300mm x 300mm) Tee	1251AN45121
15" x 15" (375mm x 375mm) Tee	551AN451518
18" x 18" (450mm x 450mm) Tee	51AN4518245
24" x 24" (600mm x 600mm) Tee	1AN4524

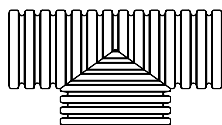

Colector sencillo

-Todos los colectores reductores de STORMTECH® son excéntricos.

TEE DOBLE PARA SC-310

Diámetros	Código
6" x 6" (150mm x 150mm) Tee	0652AN3106
8" x 8" (200mm x 200mm) Tee	0852AN3108
10" x 10" (250mm x 250mm) Tee	1052AN3110
12" x 12" (300mm x 300mm) Tee	1252AN3112

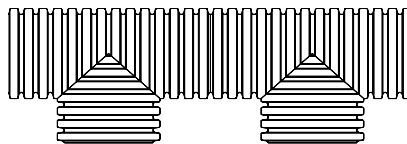

Colector doble

TEE DOBLE PARA SC-740 / DC-780

Diámetros	Código
6" x 6" (150mm x 150mm) Tee	0652AN7406
8" x 8" (200mm x 200mm) Tee	0852AN7408
10" x 10" (250mm x 250mm) Tee	1052AN7410
12" x 12" (300mm x 300mm) Tee	1252AN7412
15" x 15" (375mm x 375mm) Tee	1552AN7415
18" x 18" (450mm x 450mm) Tee	1852AN7418
24" x 24" (600mm x 600mm) Tee	2452AN7424

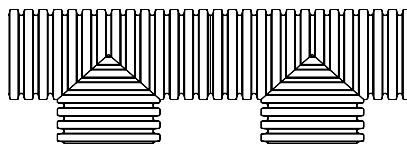

Colector doble

TEE DOBLE PARA SC-740 / DC-780

Diámetros	Código
12" x 12" (300mm x 300mm) Tee	1252AN3512
15" x 15" (375mm x 375mm) Tee	1552AN3515
18" x 18" (450mm x 450mm) Tee	1852AN3518
24" x 24" (600mm x 600mm) Tee	2452AN3524

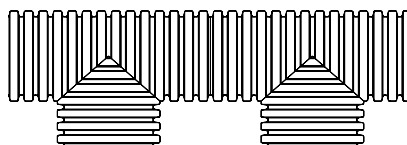

Colector doble

TEE TRIPLE PARA SC-310

Diámetros	Código
6" x 6" (150mm x 150mm) Tee	0653AN3106
8" x 8" (200mm x 200mm) Tee	0853AN3108
10" x 10" (250mm x 250mm) Tee	1053AN3110
12" x 12" (300mm x 300mm) Tee	1253AN3112

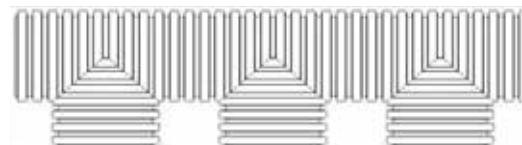

Colector triple

TEE TRIPLE PARA SC-740/DC-780

Diámetros	Código
6" x 6" (150mm x 150mm) Tee	0653AN7406
8" x 8" (200mm x 200mm) Tee	0853AN7408
10" x 10" (250mm x 250mm) Tee	1053AN7410
12" x 12" (300mm x 300mm) Tee	1253AN7412
15" x 15" (375mm x 375mm) Tee	1553AN7415
18" x 18" (450mm x 450mm) Tee	1853AN7418
24" x 24" (600mm x 600mm) Tee	2453AN7424

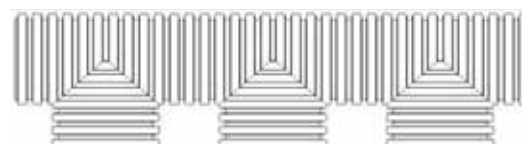

Colector triple

-Todos los colectores reductores de STORMTECH® son excéntricos.

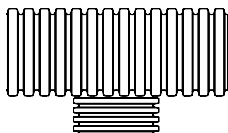

Colector reductor sencillo

TEE REDUCTR SENCILLO PARA SC-310

Diámetros	Código
8" x 6" (200mm x 150mm) Tee	0851AN3106
10" x 6" (250mm x 150mm) Tee	1051AN3106
10" x 8" (250mm x 200mm) Tee	1051AN3108
12" x 6" (300mm x 150mm) Tee	1251AN3106
12" x 8" (300mm x 200mm) Tee	1251AN3108
12" x 10" (300mm x 250mm) Tee	1251AN3110
15" x 6" (375mm x 150mm) Tee	1551AN3106
15" x 8" (375mm x 200mm) Tee	1551AN3108
15" x 10" (375mm x 250mm) Tee	1551AN3110
15" x 12" (375mm x 300mm) Tee	1551AN3112
18" x 6" (450mm x 150mm) Tee	1851AN3106
18" x 8" (450mm x 200mm) Tee	1851AN3108
18" x 10" (450mm x 250mm) Tee	1851AN3110
18" x 12" (450mm x 300mm) Tee	1851AN3112
24" x 6" (600mm x 150mm) Tee	2451AN3106
24" x 8" (600mm x 200mm) Tee	2451AN3108
24" x 10" (600mm x 250mm) Tee	2451AN3110
24" x 12" (600mm x 300mm) Tee	2451AN3112

TEE REDUCTR SENCILLO PARA SC-740/DC-780

Diámetros	Código
8" x 6" (200mm x 150mm) Tee	0851AN7406
10" x 6" (250mm x 150mm) Tee	1051AN7406
10" x 8" (250mm x 200mm) Tee	1051AN7408
12" x 6" (300mm x 150mm) Tee	1251AN7406
12" x 8" (300mm x 200mm) Tee	1251AN7408
12" x 10" (300mm x 250mm) Tee	1251AN7410
15" x 6" (375mm x 150mm) Tee	1551AN7406
15" x 8" (375mm x 200mm) Tee	1551AN7408
15" x 10" (375mm x 250mm) Tee	1551AN7410
15" x 12" (375mm x 300mm) Tee	1551AN7412
18" x 6" (450mm x 150mm) Tee	1851AN7406
18" x 8" (450mm x 200mm) Tee	1851AN7408
18" x 10" (450mm x 250mm) Tee	1851AN7410
18" x 12" (450mm x 300mm) Tee	1851AN7412
18" x 15" (450mm x 375mm) Tee	1851AN7415
24" x 6" (600mm x 150mm) Tee	2451AN7406
24" x 8" (600mm x 200mm) Tee	2451AN7408
24" x 10" (600mm x 250mm) Tee	2451AN7410
24" x 12" (600mm x 300mm) Tee	2451AN7412
24" x 15" (600mm x 375mm) Tee	2451AN7415
24" x 18" (600mm x 450mm) Tee	2451AN7418
30" x 6" (750mm x 150mm) Tee	3051AN7406
30" x 12" (750mm x 300mm) Tee	3051AN7412
30" x 15" (750mm x 375mm) Tee	3051AN7415
30" x 18" (750mm x 450mm) Tee	3051AN7418
30" x 24" (750mm x 600mm) Tee	3051AN7424
36" x 12" (900mm x 300mm) Tee	3651AN7412
36" x 15" (900mm x 375mm) Tee	3651AN7415
36" x 18" (900mm x 450mm) Tee	3651AN7418
36" x 24" (900mm x 600mm) Tee	3651AN7424
42" x 12" (1050mm x 300mm) Tee	4251AN7412
42" x 15" (1050mm x 375mm) Tee	4251AN7415
42" x 18" (1050mm x 450mm) Tee	4251AN7418
42" x 24" (1050mm x 600mm) Tee	4251AN7424
48" x 12" (1200mm x 300mm) Tee	4851AN7412
48" x 15" (1200mm x 375mm) Tee	4851AN7415
48" x 18" (1200mm x 450mm) Tee	4851AN7418
48" x 24" (1200mm x 600mm) Tee	4851AN7424

-Todos los colectores reductores de STORMTECH® son excéntricos.

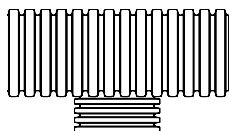

Colector reductor sencillo**

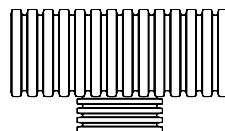

Colector reductor sencillo**

TEE REDUCTOR SENCILLO PARA MC-3500	
Diámetros	Código
15" x 12" (375mm x 300mm) Tee	1551AN3512
18" x 12" (450mm x 300mm) Tee	1851AN3512
18" x 15" (450mm x 375mm) Tee	1851AN3515
24" x 12" (600mm x 300mm) Tee	2451AN3512
24" x 15" (600mm x 375mm) Tee	2451AN3515
24" x 18" (600mm x 450mm) Tee	2451AN3518
30" x 12" (750mm x 300mm) Tee	3051AN3512
30" x 15" (750mm x 375mm) Tee	3051AN3515
30" x 18" (750mm x 450mm) Tee	3051AN3518
30" x 24" (750mm x 600mm) Tee	3051AN3524
36" x 12" (750mm x 300mm) Tee	3651AN3512
36" x 15" (750mm x 375mm) Tee	3651AN3515
36" x 18" (750mm x 450mm) Tee	3651AN3518
36" x 24" (750mm x 600mm) Tee	3651AN3524
42" x 12" (750mm x 300mm) Tee	4251AN3512
42" x 15" (750mm x 375mm) Tee	4251AN3515
42" x 18" (750mm x 450mm) Tee	4251AN3518
42" x 24" (750mm x 600mm) Tee	4251AN3524
48" x 12" (1200mm x 300mm) Tee	4851AN3512
48" x 15" (1200mm x 375mm) Tee	4851AN3515
48" x 18" (1200mm x 450mm) Tee	4851AN3518
48" x 24" (1200mm x 600mm) Tee	4851AN3524

TEE REDUCTOR SENCILLO PARA MC-4500	
Diámetros	Código
15" x 12" (375mm x 300mm) Tee	1551AN4512
18" x 12" (450mm x 300mm) Tee	1851AN4512
18" x 15" (450mm x 375mm) Tee	1851AN4515
24" x 12" (600mm x 300mm) Tee	2451AN4512
24" x 15" (600mm x 375mm) Tee	2451AN4515
24" x 18" (600mm x 450mm) Tee	2451AN4518
30" x 12" (750mm x 300mm) Tee	3051AN4512
30" x 15" (750mm x 375mm) Tee	3051AN4515
30" x 18" (750mm x 450mm) Tee	3051AN4518
30" x 24" (750mm x 600mm) Tee	3051AN4524
36" x 12" (750mm x 300mm) Tee	3651AN4512
36" x 15" (750mm x 375mm) Tee	3651AN4515
36" x 18" (750mm x 450mm) Tee	3651AN4518
36" x 24" (750mm x 600mm) Tee	3651AN4524
42" x 12" (750mm x 300mm) Tee	4251AN4512
42" x 15" (750mm x 375mm) Tee	4251AN4515
42" x 18" (750mm x 450mm) Tee	4251AN4518
42" x 24" (750mm x 600mm) Tee	4251AN4524
48" x 12" (1200mm x 300mm) Tee	4851AN4512
48" x 15" (1200mm x 375mm) Tee	4851AN4515
48" x 18" (1200mm x 450mm) Tee	4851AN4518
48" x 24" (1200mm x 600mm) Tee	4851AN4524

-Todos los colectores reductores de STORMTECH® son excéntricos.

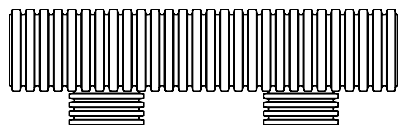

Colector reductor doble**

TEE REDUCTOR DOBLE PARA SC-310

Diámetros	Código
8" x 6" (200mm x 150mm) Tee	0852AN3106
10" x 6" (250mm x 150mm) Tee	1052AN3106
10" x 8" (250mm x 200mm) Tee	1052AN3108
12" x 6" (300mm x 150mm) Tee	1252AN3106
12" x 8" (300mm x 200mm) Tee	1252AN3108
12" x 10" (300mm x 250mm) Tee	1252AN3110
15" x 6" (375mm x 150mm) Tee	1552AN3106
15" x 8" (375mm x 200mm) Tee	1552AN3108
15" x 10" (375mm x 250mm) Tee	1552AN3110
15" x 12" (375mm x 300mm) Tee	1552AN3112
18" x 6" (450mm x 150mm) Tee	1852AN3106
18" x 8" (450mm x 200mm) Tee	1852AN3108
18" x 10" (450mm x 250mm) Tee	1852AN3110
18" x 12" (450mm x 300mm) Tee	1852AN3112
24" x 6" (600mm x 150mm) Tee	2452AN3106
24" x 8" (600mm x 200mm) Tee	2452AN3108
24" x 10" (600mm x 250mm) Tee	2452AN3110
24" x 12" (600mm x 300mm) Tee	2452AN3112

TEE REDUCTOR DOBLE PARA SC-740/DC-780

Diámetros	Código
8" x 6" (200mm x 150mm) Tee	0852AN7406
10" x 6" (250mm x 150mm) Tee	1052AN7406
10" x 8" (250mm x 200mm) Tee	1052AN7408
12" x 6" (300mm x 150mm) Tee	1252AN7406
12" x 8" (300mm x 200mm) Tee	1252AN7408
12" x 10" (300mm x 250mm) Tee	1252AN7410
15" x 6" (375mm x 150mm) Tee	1552AN7406
15" x 8" (375mm x 200mm) Tee	1552AN7408
15" x 10" (375mm x 250mm) Tee	1552AN7410
15" x 12" (375mm x 300mm) Tee	1552AN7412
18" x 6" (450mm x 150mm) Tee	1852AN7406
18" x 8" (450mm x 200mm) Tee	1852AN7408
18" x 10" (450mm x 250mm) Tee	1852AN7410
18" x 12" (450mm x 300mm) Tee	1852AN7412
18" x 15" (450mm x 375mm) Tee	1852AN7415
24" x 6" (600mm x 150mm) Tee	2452AN7406
24" x 8" (600mm x 200mm) Tee	2452AN7408
24" x 10" (600mm x 250mm) Tee	2452AN7410
24" x 12" (600mm x 300mm) Tee	2452AN7412
24" x 15" (600mm x 375mm) Tee	2452AN7415
24" x 18" (600mm x 450mm) Tee	2452AN7418
30" x 6" (750mm x 150mm) Tee	3052AN7406
30" x 12" (750mm x 300mm) Tee	3052AN7412
30" x 15" (750mm x 375mm) Tee	3052AN7415
30" x 18" (750mm x 450mm) Tee	3052AN7418
30" x 24" (750mm x 600mm) Tee	3052AN7424
36" x 12" (900mm x 300mm) Tee	3652AN7412
36" x 15" (900mm x 375mm) Tee	3652AN7415
36" x 18" (900mm x 450mm) Tee	3652AN7418
36" x 24" (900mm x 600mm) Tee	3652AN7424
42" x 12" (1050mm x 300mm) Tee	4252AN7412
42" x 15" (1050mm x 375mm) Tee	4252AN7415
42" x 18" (1050mm x 450mm) Tee	4252AN7418
42" x 24" (1050mm x 600mm) Tee	4252AN7424
48" x 12" (1200mm x 300mm) Tee	4852AN7412
48" x 15" (1200mm x 375mm) Tee	4852AN7415
48" x 18" (1200mm x 450mm) Tee	4852AN7418
48" x 24" (1200mm x 600mm) Tee	4852AN7424

-Todos los colectores reductores de STORMTECH® son excéntricos.

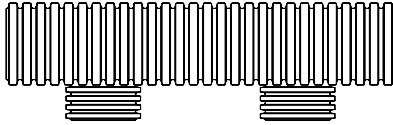

Colector reductor doble**

TEE REDUCTOR DOBLE PARA MC-3500

Diámetros	Código
15" x 12" (375mm x 300mm) Tee	1552AN3512
18" x 12" (450mm x 300mm) Tee	1852AN3512
18" x 15" (450mm x 375mm) Tee	1852AN3515
24" x 12" (600mm x 300mm) Tee	2452AN3512
24" x 15" (600mm x 375mm) Tee	2452AN3515
24" x 18" (600mm x 450mm) Tee	2452AN3518
30" x 12" (750mm x 300mm) Tee	3052AN3512
30" x 15" (750mm x 375mm) Tee	3052AN3515
30" x 18" (750mm x 450mm) Tee	3052AN3518
30" x 24" (750mm x 600mm) Tee	3052AN3524
36" x 12" (750mm x 300mm) Tee	3652AN3512
36" x 15" (750mm x 375mm) Tee	3652AN3515
36" x 18" (750mm x 450mm) Tee	3652AN3518
36" x 24" (750mm x 600mm) Tee	3652AN3524
42" x 12" (750mm x 300mm) Tee	4252AN3512
42" x 15" (750mm x 375mm) Tee	4252AN3515
42" x 18" (750mm x 450mm) Tee	4252AN3518
42" x 24" (750mm x 600mm) Tee	4252AN3524
48" x 12" (1200mm x 300mm) Tee	4852AN3512
48" x 15" (1200mm x 375mm) Tee	4852AN3515
48" x 18" (1200mm x 450mm) Tee	4852AN3518
48" x 24" (1200mm x 600mm) Tee	4852AN3524

-Todos los colectores reductores de STORMTECH® son excéntricos.

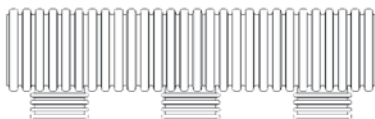

Colector reductor triple**

TEE REDUCTOR TRIPLE PARA SC-310

Diámetros	Código
8" x 6" (200mm x 150mm) Tee	0853AN3106
10" x 6" (250mm x 150mm) Tee	1053AN3106
10" x 8" (250mm x 200mm) Tee	1053AN3108
12" x 6" (300mm x 150mm) Tee	1253AN3106
12" x 8" (300mm x 200mm) Tee	1253AN3108
12" x 10" (300mm x 250mm) Tee	1253AN3110
15" x 6" (375mm x 150mm) Tee	1553AN3106
15" x 8" (375mm x 200mm) Tee	1553AN3108
15" x 10" (375mm x 250mm) Tee	1553AN3110
15" x 12" (375mm x 300mm) Tee	1553AN3112
18" x 6" (450mm x 150mm) Tee	1853AN3106
18" x 8" (450mm x 200mm) Tee	1853AN3108
18" x 10" (450mm x 250mm) Tee	1853AN3110
18" x 12" (450mm x 300mm) Tee	1853AN3112
24" x 6" (600mm x 150mm) Tee	2453AN3106
24" x 8" (600mm x 200mm) Tee	2453AN3108
24" x 10" (600mm x 250mm) Tee	2453AN3110
24" x 12" (600mm x 300mm) Tee	2453AN3112

TEE REDUCTOR TRIPLE PARA SC-740/DC-780

Diámetros	Código
8" x 6" (200mm x 150mm) Tee	0853AN7406
10" x 6" (250mm x 150mm) Tee	1053AN7406
10" x 8" (250mm x 200mm) Tee	1053AN7408
12" x 6" (300mm x 150mm) Tee	1253AN7406
12" x 8" (300mm x 200mm) Tee	1253AN7408
12" x 10" (300mm x 250mm) Tee	1253AN7410
15" x 6" (375mm x 150mm) Tee	1553AN7406
15" x 8" (375mm x 200mm) Tee	1553AN7408
15" x 10" (375mm x 250mm) Tee	1553AN7410
15" x 12" (375mm x 300mm) Tee	1553AN7412
18" x 6" (450mm x 150mm) Tee	1853AN7406
18" x 8" (450mm x 200mm) Tee	1853AN7408
18" x 10" (450mm x 250mm) Tee	1853AN7410
18" x 12" (450mm x 300mm) Tee	1853AN7412
18" x 15" (450mm x 375mm) Tee	1853AN7415
24" x 6" (600mm x 150mm) Tee	2453AN7406
24" x 8" (600mm x 200mm) Tee	2453AN7408
24" x 10" (600mm x 250mm) Tee	2453AN7410
24" x 12" (600mm x 300mm) Tee	2453AN7412
24" x 15" (600mm x 375mm) Tee	2453AN7415
24" x 18" (600mm x 450mm) Tee	2453AN7418
30" x 6" (750mm x 150mm) Tee	3053AN7406
30" x 12" (750mm x 300mm) Tee	3053AN7412
30" x 15" (750mm x 375mm) Tee	3053AN7415
30" x 18" (750mm x 450mm) Tee	3053AN7418
30" x 24" (750mm x 600mm) Tee	3053AN7424
36" x 12" (900mm x 300mm) Tee	3653AN7412
36" x 15" (900mm x 375mm) Tee	3653AN7415
36" x 18" (900mm x 450mm) Tee	3653AN7418
36" x 24" (900mm x 600mm) Tee	3653AN7424
42" x 12" (1050mm x 300mm) Tee	4253AN7412
42" x 15" (1050mm x 375mm) Tee	4253AN7415
42" x 18" (1050mm x 450mm) Tee	4253AN7418
42" x 24" (1050mm x 600mm) Tee	4253AN7424
48" x 12" (1200mm x 300mm) Tee	4853AN7412
48" x 15" (1200mm x 375mm) Tee	4853AN7415
48" x 18" (1200mm x 450mm) Tee	4853AN7418
48" x 24" (1200mm x 600mm) Tee	4853AN7424

-Todos los colectores reductores de STORMTECH® son excéntricos.

Unidades de Calidad de Agua Interceptor de Grasa

Tratamiento de agua pluvial

MÓDULO 1

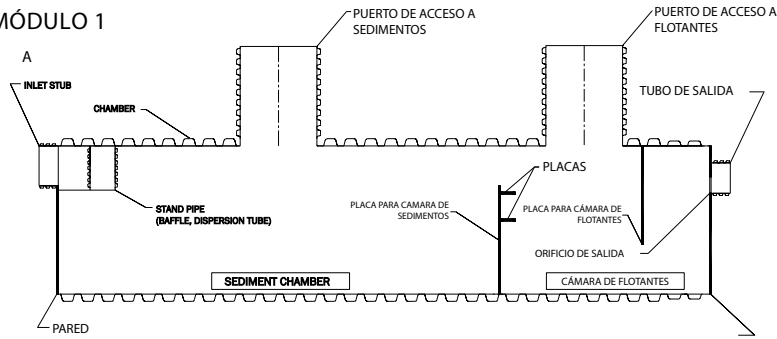

UNIDADES DE CALIDAD DE AGUA

Diámetros	Longitud	Diámetro de entrada	Diámetro de salida	Flujo tratado	Código
36" (900mm)	20' (6.1m)	10" (250mm)	10" (250mm)	1.5 cfs (42 L/s)	3620WQA
36" (900mm)	40' (12.2m)	10" (250mm)	10" (250mm)	2.38 cfs (67 L/s)	3640WQA
36" (900mm)	20' (6.1m)	10" (250mm)	10" (250mm)	0.7 cfs (20 L/s)	3620WQB
36" (900mm)	40' (12.2m)	10" (250mm)	10" (250mm)	1.6 cfs (45 L/s)	3640WQB
42" (1050mm)	20' (6.1m)	12" (300mm)	12" (300mm)	1.79 cfs (49 L/s)	4220WQA
42" (1050mm)	40' (12.2m)	12" (300mm)	12" (300mm)	3.66 cfs (104 L/s)	4240WQA
42" (1050mm)	20' (6.1m)	12" (300mm)	12" (300mm)	0.86 cfs (24 L/s)	4220WQB
42" (1050mm)	40' (12.2m)	12" (300mm)	12" (300mm)	1.83 cfs (52 L/s)	4240WQB
48" (1200mm)	20' (6.1m)	12" (300mm)	12" (300mm)	2.26 cfs (64 L/s)	4820WQA
48" (1200mm)	40' (12.2m)	12" (300mm)	12" (300mm)	3.94 cfs (112 L/s)	4840WQA
48" (1200mm)	20' (6.1m)	12" (300mm)	12" (300mm)	1.13 cfs (32 L/s)	4820WQB
48" (1200mm)	40' (12.2m)	12" (300mm)	12" (300mm)	2.39 cfs (68 L/s)	4840WQB
60" (1500mm)	20' (6.1m)	15" (375mm)	15" (375mm)	2.95 cfs (84 L/s)	6020WQA
60" (1500mm)	40' (12.2m)	15" (375mm)	15" (375mm)	6.23 cfs (176 L/s)	6040WQA
60" (1500mm)	20' (6.1m)	15" (375mm)	15" (375mm)	1.47 cfs (42 L/s)	6020WQB
60" (1500mm)	40' (12.2m)	15" (375mm)	15" (375mm)	3.12 cfs (88 L/s)	6040WQB

Agrega dos dígitos al final del producto para el diámetro del bypass.
00 al final del código de producto indica que no existe bypass.

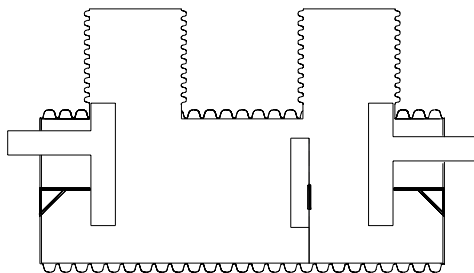

Interceptor de grasa

INTERCEPTOR DE GRASA

Diámetros	Volúmen	Código
48" (1200mm)	750 gal (2839 liters)	0750ANGT
48" (1200mm)	1000 gal (3785 liters)	1000ANGT
60" (1200mm)	1500 gal (5678 liters)	1500ANGT



FILTROS PARA MARCOS / REJILLAS REDONDOS*

Guía de dimensiones (Diámetro de filtro)	Capacidad de almacenaje ft ³ (m ³)	FX-Large (Sedimentos + Basura)	Precio	FX+ (Basura + Aceites)	Precio	PC (Aceites, Sedimentos finos y Sólidos)	Precio	PC+ (Exceso de aceite, Sedimentos finos y sólidos)	Precio
18" (450 mm)	1.6 (0.05)	62SHDRFX	*	62SHDRFXP	*	62SHDRPC	*	62SHDRPCP	*
24" (600 mm)	2.1 (0.06)	62MHRFX	*	62MHRFXP	*	62MHRPC	*	62MHRPCP	*
36" (900 mm)	3.8 (0.11)	62LHRFX	*	62LHRFXP	*	62LHRPC	*	62LHRPCP	*
42" (1050 mm)	4.2 (0.12)	62XLHRFX	*	62XLHRFXP	*	62XLHRPC	*	62XLHRPCP	*

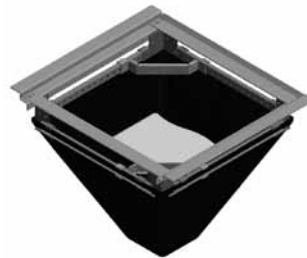

FILTROS PARA MARCOS RECTANGULARES / CUADRADOS / REJILLAS*

Guía de dimensiones (Up to)	Capacidad de almacenaje ft ³ (m ³)	FX-Large (Sedimentos + Basura)	Precio	FX+ (Basura + Aceites)	Precio	PC (Aceites, Sedimentos finos y Sólidos)	Precio	PC+ (Exceso de aceite, Sedimentos finos y sólidos)	Precio
16" x 16" (400 x 400 mm)	1.6 (0.05)	62SHDFX	*	62SHDFXP	*	62SHDPC	*	62SHDPCP	*
24" x 24" (600 x 600 mm)	2.1 (0.06)	62MHDFX	*	62MHDFXP	*	62MHDPC	*	62MHDPCP	*
36" x 24" (900 x 600 mm)	3.8 (0.11)	62LHDFX	*	62LHDFXP	*	62LHDPC	*	62LHDPCP	*
48" x 48" (1200 x 1200 mm)	6.6 (0.18)	62XLHDFX	*	62XLHDFXP	*	62XLHDPC	*	62XLHDPCP	*



FILTROS PARA ENTRADA PARA BANQUETA ABIERTA *

Guía de dimensiones	Capacidad de almacenaje ft ³ (m ³)	FX-Large (Sedimentos + Basura)	FX+ (Basura + Aceites)	PC (Aceites, Sedimentos finos y Sólidos)	PC+ (Exceso de aceite, Sedimentos finos y sólidos)
Up to 4' (1.2 m)	3.3 (0.09)	62SHDFX	6HDWM1FXP	6HDWM1PC	6HDWM1PCP
Between 4' & 8' (1.2 & 2.4 m)	6.6 (0.18)	62MHDFX	62HDWM2FXP	62HDWM2PC	62HDWM2PCP
Between 8' & 12' (2.4 & 3.7 m)	9.9 (0.28)	62LHDFX	62HDWM3FXP	62HDWM3PC	62HDWM3PCP
Between 12' & 16' (3.6 m & 4.9 m)	13.2 (0.37)	62XLHDFX	62HDWM4FXP	62HDWM4PC	62HDWM4PCP

-Tamaños y alturas de filtros disponibles. Altura típica de 22" (550 mm)

FILTROS PARA MARCOS / REJILLAS REDONDOS *

Tamaño de filtro	FX Tejido estándar
18" (450 mm)	62SRDFX
25" (625 mm)	62MRDFX
30" (750 mm)	62LRDFX
37" (925 mm)	62XLRDFX
48" (1200 mm)	62XXLRDFX



FILTROS PARA MARCOS RECTANGULARES / CUADRADOS / REJILLAS*

Tamaño de filtro	FX Tejido estándar
16" x 16" (400 x 400 mm)	62SSQFX
24" x 24" (600 x 600 mm)	62MSQFX
36" x 24" (900 x 600 mm)	62LSQFX
48" x 48" (1200 x 1200 mm)	62XLSQFX

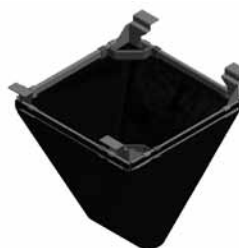

FILTROS PARA RECTANGULARES MARCOS / REJAS / BANQUETA CUBIERTA

Tamaño de filtro	FX Tejido estándar
16" x 16" (400 x 400 mm)	62SCBFX
24" x 24" (600 x 600 mm)	62MCBFX
36" x 24" (900 x 600 mm)	62LCBFX
48" x 48" (1200 x 1200 mm)	62XLCBFX



FILTROS CATCH-IT LITE

Tipo de rejilla	Código
Square/Rectangular	62LITE
Square/Rectangular with Curb Opening	62LITECB
Round Frame/Grate	62LITERD



62LITE



62LITECB

-Tamaños y alturas de filtros disponibles. Altura típica de 22" (550 mm)

Filtros de Nyloplast®, repuesto de bolsas y accesorios

Flexstorm® Filtros de entrada



FILTRO REDONDO PARA NYLOPLAST DE ACERO INOXIDABLE

Diametro de filtro	FX (Tejido estándar)	FX+ (Tejido con MyCelx)	PC (Post-Construcción)	PC+ (PC con MyCelx)	LL (Geotextil Tejido)
8" (200 mm) Drop In/In Line Grates	6208NYFX	6208NYFXP	6208NYPC	6208NYPCP	6208NYLL
10" (250 mm) Drop In/In Line Grates	6210NYFX	6210NYFXP	6210NYPC	6210NYPCP	6210NYLL
12" (300 mm) Nyloplast Casting	6212NYFX	6212NYFXP	6212NYPC	6212NYPCP	6212NYLL
15" (375 mm) Nyloplast Casting	6215NYFX	6215NYFXP	6215NYPC	6215NYPCP	6215NYLL
18" (450 mm) Nyloplast Casting	6218NYFX	6218NYFXP	6218NYPC	6218NYPCP	6218NYLL
24" (600 mm) Nyloplast Casting	6224NYFX	6224NYFXP	6224NYPC	6224NYPCP	6224NYLL
30" (750 mm) Nyloplast Casting	6230NYFX	6230NYFXP	6230NYPC	6230NYPCP	6230NYLL

REPUESTO DE BOLSAS*

Tamaño de filtro (Circular o rectangular)	FX	FX+	PC	PC+
Small	62SRBFX	62SRBFXP	62SRBPC	62SRBPCP
Medium	62MRBFX	62MRBFXP	62MRBPC	62MRBPCP
Large	62LRBFX	62LRBFXP	62LRBPC	62LRBPCP
X-Large (Round only)	62XLRBFX	62XLRBFXP	62XLRBPC	62XLRBPCP

-La altura de los filtros de la lista anterior es de 22" (55.8 cm). En caso de requerir un filtro de 12" de altura agregue una "S" al final del código.

BOLSA DE GOMA PARA LIMPIEZA DE ACEITE

Tamaño de filtro	PC+
Standard Skimmer Pouch with Swivel Hook/Strap	62CTS8
3" diameter x 34" Long Skimmer Boom with Swivel Hook/Strap	62CTS34

HERRAMIENTA DE MANTENIMIENTO

Descripción	Código
2-Person to Remove Grates & Filters	62UMT



-Tamaños y alturas de filtros disponibles. Altura típica de 22" (550 mm)



Filtro de rejilla redondo



Filtro de rejilla cuadrado / rectangular

Insertos de captura de residuos*

Descripción	Dimensiones	Profundidad	Código
12" x 12" (300 x 300 mm) Full Trash Capture Insert	12" x 12" (300 x 300 mm)	12" (300 mm)	62HD12FTC
18" x 18" (450 x 450 mm) Full Trash Capture Insert	18" x 18" (450 x 450 mm)	12" (300 mm)	62HD18FTC
24" x 24" (600 x 600 mm) Full Trash Capture Insert	24" x 24" (600 x 600 mm)	12" (300 mm)	62HD24FTC
36" x 18" (900 x 450 mm) Full Trash Capture Insert	36" x 18" (900 x 450 mm)	12" (300 mm)	62HD3618FTC
36" x 24" (900 x 600 mm) Full Trash Capture Insert	36" x 24" (900 x 600 mm)	12" (300 mm)	62HD3624FTC
36" x 36" (900 x 900 mm) Full Trash Capture Insert	36" x 36" (900 x 900 mm)	12" (300 mm)	62HD36FTC

- Custom sizes and basket depths available.



Inserto de entrada a la acera

Inserto de entrada a la acera*

Descripción	Ancho de apertura in. (mm)	Profundidad	Código
36" (900 mm) Curb Inlet Full Trash Capture Insert	36" (900 mm)	12" (300 mm)	62HDWM36FTC
42" (1050 mm) Curb Inlet Full Trash Capture Insert	42" (1050 mm)	12" (300 mm)	62HDWM42FTC
48" (1200 mm) Curb Inlet Full Trash Capture Insert	48" (1200 mm)	12" (300 mm)	62HDWM48FTC
60" (1500 mm) Curb Inlet Full Trash Capture Insert	60" (1500 mm)	12" (300 mm)	62HDWM60FTC
72" (1800 mm) Curb Inlet Full Trash Capture Insert	72" (1800 mm)	12" (300 mm)	62HDWM72FTC
84" (2100 mm) Curb Inlet Full Trash Capture Insert	84" (2100 mm)	12" (300 mm)	62HDWM84FTC
96" (2400 mm) Curb Inlet Full Trash Capture Insert	96" (2400 mm)	12" (300 mm)	62HDWM96FTC
120" (3000 mm) Curb Inlet Full Trash Capture Insert	120" (3000 mm)	12" (300 mm)	62HDWM120FTC

- Custom sizes and basket depths available.

-Tamaños y alturas de filtros disponibles. Altura típica de 22" (550 mm)



PANTALLA DE TUBERÍA DE CONEXIÓN (FORMA EN U)*

Descripción	Longitud	Altura	Código	Referencia
36" x 18" (900 x 450 mm) Connector Pipe Screen	36" (900 mm)	18" (450 mm)	62CPS	3L18H-Bypass-U
48" x 18" (1200 x 450 mm) Connector Pipe Screen	48" (1200 mm)	18" (450 mm)	62CPS	4L18H-Bypass-U
60" x 18" (1500 x 450 mm) Connector Pipe Screen	60" (1500 mm)	18" (450 mm)	62CPS	5L18H-Bypass-U

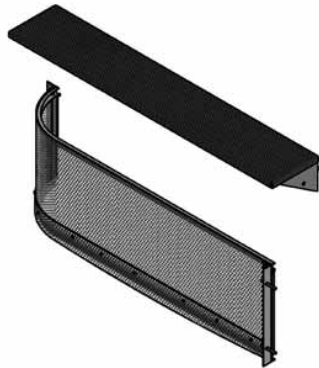

PANTALLA DE TUBERÍA DE CONEXIÓN (FORMA EN L)*

Descripción	Longitud	Altura	Código	Referencia
36" x 18" (900 x 450 mm) Connector Pipe Screen	36" (900 mm)	18" (450 mm)	62CPS	3L18H-Bypass-L
48" x 18" (1200 x 450 mm) Connector Pipe Screen	48" (1200 mm)	18" (450 mm)	62CPS	4L18H-Bypass-L
60" x 18" (1500 x 450 mm) Connector Pipe Screen	60" (1500 mm)	18" (450 mm)	62CPS	5L18H-Bypass-L



PANTALLA DE TUBERÍA DE CONEXIÓN (FORMA EXTENDIDA EN U)*

Descripción	Longitud	Altura	Código	Referencia
36" x 18" (900 x 450 mm) Connector Pipe Screen	36" (900 mm)	18" (450 mm)	62CPS	3L18H-Bypass-UEXT
48" x 18" (1200 x 450 mm) Connector Pipe Screen	48" (1200 mm)	18" (450 mm)	62CPS	4L18H-Bypass-UEXT
60" x 18" (1500 x 450 mm) Connector Pipe Screen	60" (1500 mm)	18" (450 mm)	62CPS	5L18H-Bypass-UEXT

-Disponibles formas y tamaños personalizados. La altura de la derivación está determinada por el tamaño de la cuenca.



BAYFILTER TRATAMIENTO DE AGUA PLUVIAL

Modelo	Diámetros	Caudal	Media area	Capacidad de almacenaje de sedimentos	Código
BayFilter 545	28" (711 mm)	45 gpm (170 l/min)	90 ft² (8.4 m²)	350 lbs (159 kg)	BAYFLTR-545
BayFilter 530	28" (711 mm)	30 gpm (114 l/min)	90ft² (8.4 m²)	350 lbs (159 kg)	BAYFLTR-530
BayFilter 522	28" (711 mm)	22.5 gpm (85 l/min)	45 ft² (4.2 m²)	175 lbs (79 kg)	BAYFLTR-522
BayFilter 645	28" (711 mm)	45 gpm (170 l/min)	90 ft² (8.4 m²)	350 lbs (159 kg)	BAYFLTR-645
BayFilter 630	28" (711 mm)	30 gpm (114 l/min)	90 ft² (8.4 m²)	350 lbs (159 kg)	BAYFLTR-630
BayFilter 622	28" (711 mm)	22.5 gpm (85 l/min)	45 ft² (4.2 m²)	175 lbs (79 kg)	BAYFLTR-622

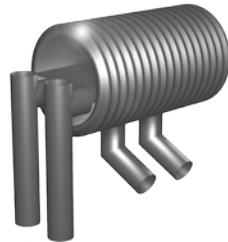

BAYFILTER FILTRO DE CONTAMINANTES DE AGUA PLUVIAL

Modelo	Diámetro del pozo	Profundidad del pozo	Tasa de tratamiento max	Tasa hidráulica max	Código
BaySeparator ½K	48" (1219 mm)	6' (1.8 m)	1.1 cfs (31.4 l/sec)	8.5 cfs (241 l/sec)	BAYSEP00500
BaySeparator 1K	48" (1219 mm)	8' (2.4 m)	2.4 cfs (68 l/sec)	10 cfs (283 l/sec)	BAYSEP01000
BaySeparator 3K	60" (1524 mm)	8' (2.4 m)	7.8 cfs (221 l/sec)	30 cfs (850 l/sec)	BAYSEP03000
BaySeparator 5K	72" (1829 mm)	8' (2.4 m)	11.1 cfs (314 l/sec)	50 cfs (1416 l/sec)	BAYSEP05000
BaySeparator 10K	120" (3048 mm)	8' (2.4 m)	21.8 cfs (617 l/sec)	100 cfs (2832 l/sec)	BAYSEP10000
BaySeparator XK	Personalizado	Personalizado	Personalizado	Personalizado	BAYSYSXK



BARRACUDA

Modelo	Diámetro del pozo	OK-110 (Eliminación del 80%)	NJCAT/NJDEP (Eliminación del 50%)	Código
S4	48" (1219 mm)	1.08 cfs (30.6 l/sec)	1.25 cfs (35.4 l/sec)	BARRACUDASYS410Z
S6	72" (1829 mm)	2.43 cfs (68.8 l/sec)	2.80 cfs (79.3 l/sec)	BARRACUDASYS610Z
S8	96" (2438 mm)	4.32 cfs (122.3 l/sec)	5.00 cfs (141.6 l/sec)	BARRACUDASYS810Z

DURASLOT ESCURRIMIENTO SUPERFICIAL		
Diámetros	Altura de ranura	Código
4" (100mm)	2.5" (64mm)	0420DS
4" (100mm)	Variable	0490DS
6" (150mm)	2.5" (64mm)	0620DS
6" (150mm)	6" (150mm)	0660DS
6" (150mm)	6" (150mm) Abierto	0660DSOT
6" (150mm)	Variable	0690DS
6" (150mm)	Variable (Abierto)	0690DSOT
8" (200mm)	2.5" (64mm)	0820DS
8" (200mm)	6" (150mm)	0860DS
8" (200mm)	6" (150mm) Abierto	0860DSOT
8" (200mm)	Variable	0890DS
8" (200mm)	Variable (Abierto)	0890DSOT
10" (250mm)	2.5" (64mm)	1020DS
10" (250mm)	6" (150mm)	1060DS
10" (250mm)	6" (150mm) Abierto	1060DSOT
10" (250mm)	Variable	1090DS
10" (250mm)	Variable (Abierto)	1090DSOT
12" (300mm)	2.5" (64mm)	1220DS
12" (300mm)	6" (150mm)	1260DS
12" (300mm)	6" (150mm) Abierto	1260DSOT
12" (300mm)	Variable	1290DS
12" (300mm)	Variable (Abierto)	1290DSOT
15" (375mm)	6" (150mm)	1560DS
15" (375mm)	6" (150mm) Abierto	1560DSOT
15" (375mm)	Variable	1590DS
15" (375mm)	Variable (Abierto)	1590DSOT
18" (450mm)	6" (150mm)	1860DS
18" (450mm)	6" (150mm) Variable	1860DSOT
18" (450mm)	Abierto	1890DS
18" (450mm)	Variable (Abierto)	1890DSOT
24" (600mm)	6" (150mm)	2460DS
24" (600mm)	6" (150mm) Abierto	2460DSOT
24" (600mm)	Variable	2490DS
24" (600mm)	Variable (Abierto)	2490DSOT
30" (750mm)	6" (150mm)	3060DS
30" (750mm)	6" (150mm) Abierto	3060DSOT
30" (750mm)	Variable	3090DS
30" (750mm)	Variable (Abierto)	3090DSOT
36" (900mm)	6" (150mm)	3660DS
36" (900mm)	Variable	3690DS
36" (900mm)	Variable (Abierto)	3690DSOT*

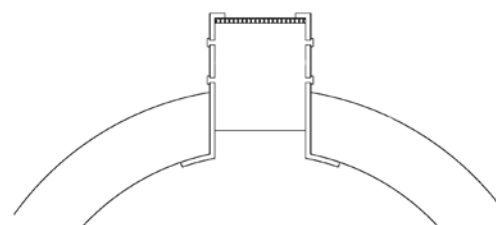
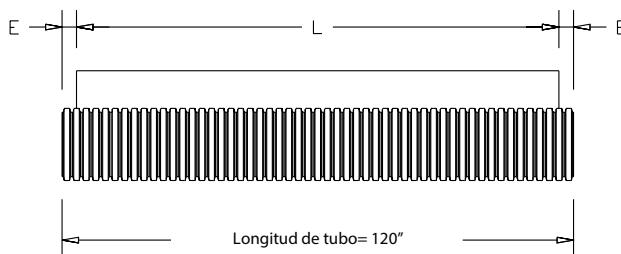

Duraslot con rejilla

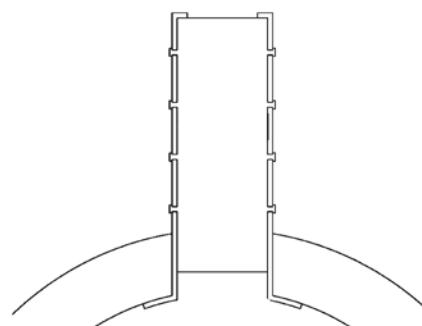

Duraslot abierto

COPLES		
Diámetros	Accesorios compatibles con los siguientes códigos	Código
4" (100mm)	0420DS	0421DS
4" (100mm)	0490DS	0491DS
6" (150mm)	0660DS	0626DS
6" (150mm)	0690DS	0691DS
8" (200mm)	0860DS	0826DS
8" (200mm)	0890DS	0891DS
10" (250mm)	1060DS	1026DS
10" (250mm)	1090DS	1091DS
12" (300mm)	1260DS	1226DS
12" (300mm)	1290DS	1291DS
15" (375mm)	1560DS	1526DS
15" (375mm)	1590DS	1591DS
18" (450mm)	1860DS	1826DS
18" (450mm)	1890DS	1891DS
24" (600mm)	2460DS	2426DS
24" (600mm)	2490DS	2491DS
30" (750mm)	3060DS	3026DS
30" (750mm)	3090DS	3091DS
36" (900mm)	3660DS	3626DS
36" (900mm)	3690DS	3691DS

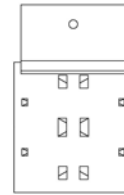

COPLES 4"

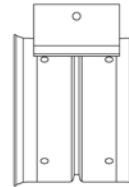

COPLES 6"



COPLES 8" y 10"

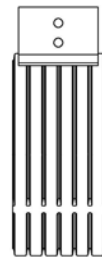

COPLES 12"-36"

Tapones		
Diámetros	Accesorios compatibles con el código del producto	Código
4" (100mm)	0420DS	0433DS
4" (100mm)	0490DS	0493DS
6" (150mm)	0660DS	0633DS
6" (150mm)	0690DS	0693DS
8" (200mm)	0860DS	0833DS
8" (200mm)	0890DS	0893DS
10" (250mm)	1060DS	1033DS
10" (250mm)	1090DS	1093DS
12" (300mm)	1260DS	1233DS
12" (300mm)	1290DS	1293DS
15" (375mm)	1560DS	1533DS
15" (375mm)	1590DS	1593DS
18" (450mm)	1860DS	1833DS
18" (450mm)	1890DS	1893DS
24" (600mm)	2460DS	2433DS
24" (600mm)	2490DS	2493DS
30" (750mm)	3060DS	3033DS
30" (750mm)	3090DS	3093DS
36" (900mm)	3660DS	3633DS
36" (900mm)	3690DS	3693DS



Tapones de 4" y 8"

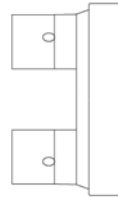

Tapones de 6" y 10"

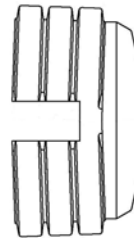

Tapones 12"-36"

ADAPTADORES		
Diámetros	Accesorios compatibles con el código del producto	Código
4" (100mm)	0420DS	0462DS
4" (100mm)	0490DS	0496DS
6" (150mm)	0660DS	0662DS
6" (150mm)	0690DS	0696DS
8" (200mm)	0860DS	0862DS
8" (200mm)	0890DS	0896DS
10" (250mm)	1060DS	1062DS
10" (250mm)	1090DS	1096DS
12" (300mm)	1260DS	1262DS
12" (300mm)	1290DS	1296DS
15" (375mm)	1560DS	1562DS
15" (375mm)	1590DS	1596DS
18" (450mm)	1860DS	1862DS
18" (450mm)	1890DS	1896DS
24" (600mm)	2460DS	2462DS
24" (600mm)	2490DS	2496DS
30" (750mm)	3060DS	3062DS
30" (750mm)	3090DS	3096DS
36" (900mm)	3660DS	3662DS
36" (900mm)	3690DS	3696DS



Adaptador 4"

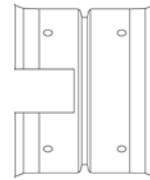

Adaptador 6"-10"

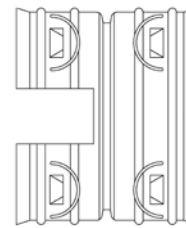

Adaptador 12"-24"

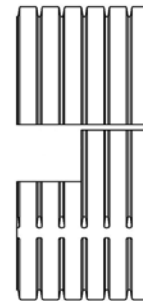

Adaptador 30"-36"

TUBERÍA ADVANEDGE® 12" Y 18"

Diámetros	Longitud	Descripción	Código
12" (300mm)	100' (30.5m)	Sin geotextil	04900100
	100' (30.5m)	Geotextil de 3.5 oz.	04910100
	100' (30.5m)	Geotextil de 4.0 oz.	04930100
	400' (121.9m)	Geotextil de 4.0 oz.	04930400
	112' (34.1m)	Geotextil de 4.0 oz.	04930112
	100' (30.5m)	Calcetín de poliester	04940100
	100' (30.5m)	Geotextil de 4.0 oz. (gris)	04950100
18" (450mm)	100' (30.5m)	Sin geotextil	06900100
	100' (30.5m)	Geotextil de 4.0 oz.	06930100
	1600' (487.7m)	Geotextil de 4.0 oz.	06931600
	100' (30.5m)	Geotextil perforado de 4.0 oz.	06950100



ACCESORIOS DE ADVANEDGE®		
Diámetros	Accesorios	Código
12" (300mm)	Tapon Snap	1432AA
18" (450mm)		1632AA
12" (300mm)	Cople Externo	1411AA
18" (450mm)		1611AA
12" (300mm)	Wye	1480AA
12" (300mm) 18" (450mm)	Perno de Sople (2/pk)	0840MB
12" (300mm)	Extremo de Salida	1472AA
18" (450mm)		1672AA
12" (300mm)	Salida Lateral	1471AA
18" (450mm)		1671AA
4" (100mm)	12" (300mm) Salida Plana	1432AN
12" (300mm)	Tee Fabricada	1460AN
18" (450mm)		1660AN
12" (300mm)	Tee Fabricada (Horizontal)	1460ANH
18" (450mm)		1660ANH
12" (300mm)	Tee Fabricada con Salida Lateral	1464ANH
12" (300mm)	Tee Fabricada con Salida Lateral Perf	1464ANH81
12" (300mm)	Tee Transversal Fabricada (Horizontal)	1436ANH
12" (300mm)	Wye Fabricada	1480AN
18" (450mm)		1680AN
12" (300mm)	Wye Fabricada (Horizontal)	1480ANH
18" (450mm)		1680ANH
12" (300mm)	Wye Transversal Fabricada	1438ANH

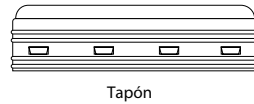

Tapón

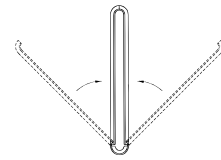

Cople abierto

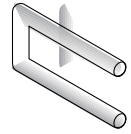

Perno de cople

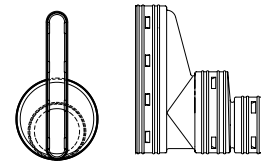

Extremo de salida

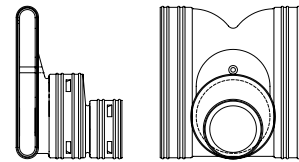

Salida lateral

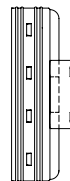

Salida plana

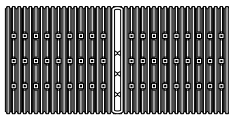
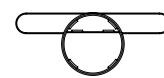
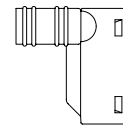

TEE Fabricada

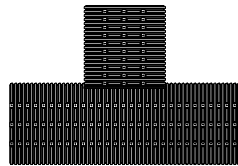

FAB TEE Fabricada (HORIZONTAL)

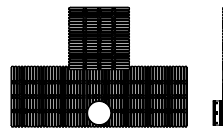

TEE Fabricada con Salida Lateral

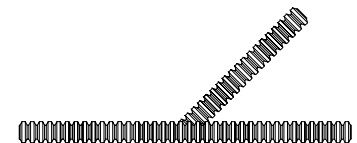

WYE

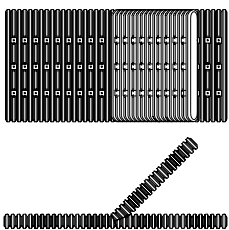

WYE Fabricada

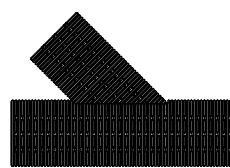

WYE Fabricada (HORIZONTAL)

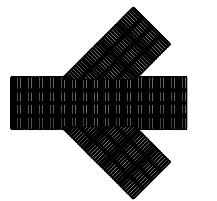

WYE Transversal Fabricada

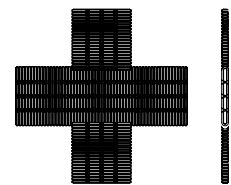

TEE Transversal Fabricada



ARC 18



ARC 24



ARC 36



ARC 36HC



ARC 36LP

ARC CHAMBERS

Modelo	Capacidad de carga	Dimensiones nominales (Lon x Anc x Alt)	Capacidad	Código
Arc 18	H-10	67" x 16" x 12" (1702 mm x 406 mm x 300 mm)	3.42 ft.3 (0.10 m ³)	1812BD
Arc 24	H-10	67" x 22.5" x 12" (1702 mm x 572 mm x 300 mm)	5.02 ft.3 (0.14 m ³)	2412BD
Arc 36	H-10	63" x 34.5" x 13" (1600 mm x 876 mm x 330 mm)	8 ft.3 (0.23 m ³)	3613BD2
Arc 36HC	H-10	63" x 34.5" x 16" (1600 mm x 876 mm x 400 mm)	10.7 ft.3 (0.30 m ³)	3616BD2
Arc 36LP	H-10	63" x 34" x 8" (1600 mm x 864 mm x 200 mm)	5.84 ft.3 (0.17 m ³)	3608BD



Tapón



Acoplador lateral

ARC Accesorios

Modelo	Código
Arc 18 Endcap	1802BD
Arc 24 Endcap	2402BD
Arc 36 Endcap	3603BD2
Arc 36HC Endcap	3606BD3
Arc 36LP Endcap	3624LPEC
Arc 24 Side Port Coupler	2403BD
Arc 36 Side Port Coupler	3604BD
Arc 36HC Side Port Coupler	3607BD
Endcap Splash Plate	0068

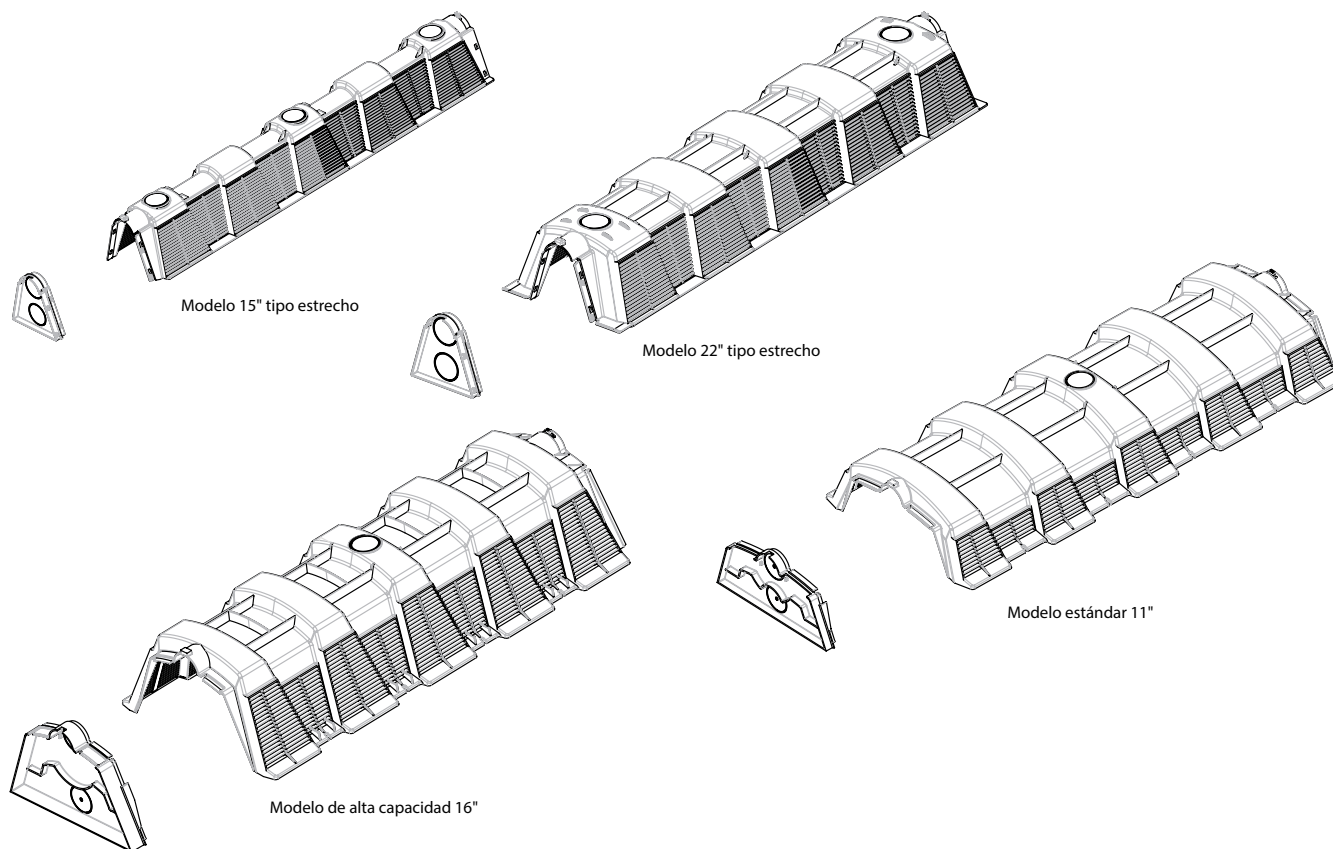

CÁMARAS BIODIFFUSER®

Tipo	Capacidad de carga	Dimensiones	Capacidad	Código
15" (375mm) Estrecho	H-10	87" x 15" x 12" (2210mm x 375mm x 300mm)	5.0 cu. ft. (0.14m ³)	1500BD
22" (560mm) Estrecho	H-10	87" x 22" x 12" (2210mm x 560mm x 300mm)	8.5 cu. ft. (0.24m ³)	2200BD
11" (280mm) Estándar	H-10	76" x 34" x 11" (1930mm x 863mm x 280mm)	9.2 cu. ft. (0.26m ³)	1100BD
16" (400mm) Alta capacidad	H-10	76" x 34" x 16" (1930mm x 863mm x 400mm)	13.6 cu. ft. (0.39m ³)	1600BD
16" (400mm) Alta capacidad	H-20	76" x 34" x 16" (1930mm x 863mm x 400mm)	13.6 cu. ft. (0.39m ³)	1620BD

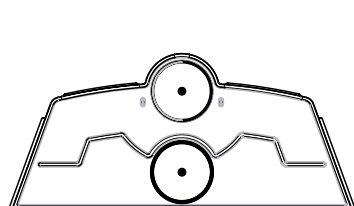

Tapa estándar de 11"

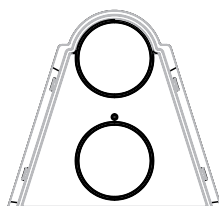

Tapa estrecha de 15" y 22"

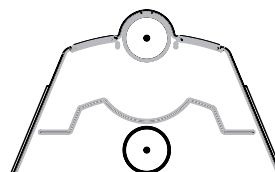

Tapa de alta capacidad 16"

ACCESORIOS BIODIFFUSER®

Tipo	Código
11" (280mm) Tapa	1101BD
11" (280mm) Sección de ángulo 0°-22°	1122BD
16" (400mm) Tapa	1601BD
16" (400mm) Sección de ángulo 0°-22°	1622BD
15" (375mm) Tapa	1501BD
15" (375mm) Sección de ángulo 0°-22°	1522BD

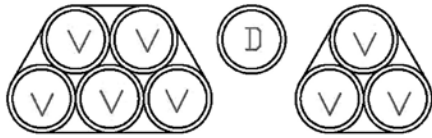

9 Tubería Septic Stack

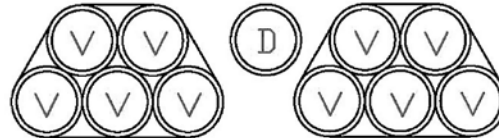

11 Tubería Septic Stack

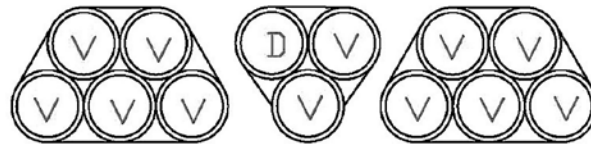

13 Tubería Septic Stack

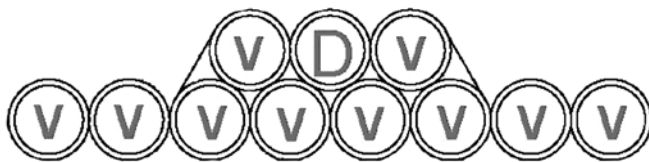

Sistema 3611

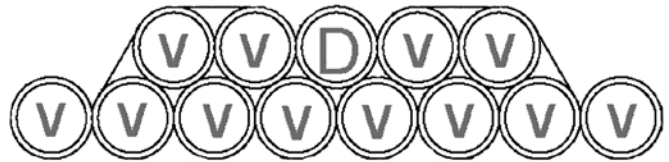

Sistema 3613

SISTEMA SEPTIC STACK

Descripción	Longitud	Código
4" (100 mm) Perforated 9 Pipe at 10' (3 m) each	10' (3 m)	04710090
4" (100 mm) Perforated 11 Pipe at 10' (3 m) each	10' (3 m)	04710110
4" (100 mm) Perforated 13 Pipe at 10' (3 m) each	10' (3 m)	04710130
3611 System of 4" (100 mm) Perforated Pipe	10' (3 m)	04710110
3613 System of 4" (100 mm) Perforated Pipe	10' (3 m)	04710130



Válvula de paso

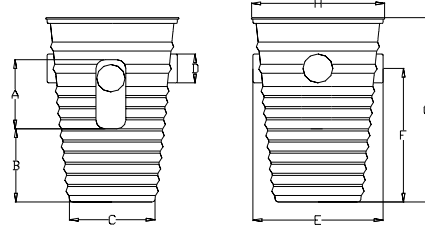
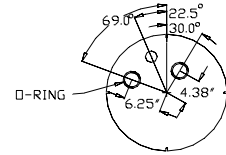

Sumidero y tapa del eyector

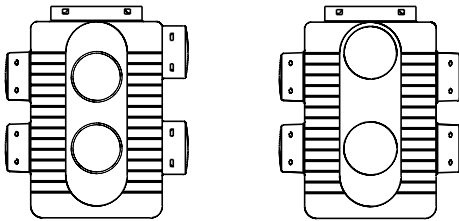

Caja de distribución multiple lateral

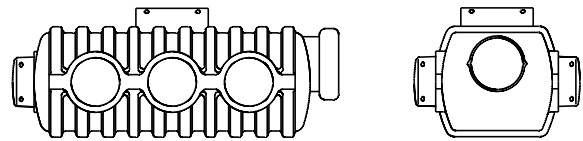

Caja de distribución multiple estándar

ACCESORIOS DE AGUAS RESIDUALES

Descripción	Código
Válvula de paso con llave de 24" (600mm)	4182FG
Caja de distribución multiple estándar	1369AB
Caja de distribución multiple lateral	1370AB
Enchufe para caja de distribución estándar	1379AB
Enchufe para caja de distribución lateral	1380AB
Kit de tapa para sumidero inyector y sumidero con ventilación radón	1530ADLX
18" x 30" Sumidero inyector con cubo de PVC	1530ADE

CODOS Y DEFLECTORES VENTILADOS

Descripción	Código
4" (100mm) Codo ventilado	0497AA
4" (100mm) Codo ventilado	0497AAFL-
4" (100mm) Deflector ventilado, 3" (75mm) espuela	0493AA

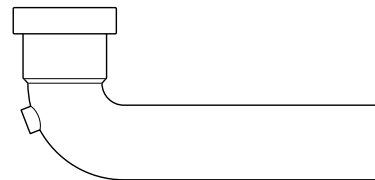

Codo ventilado

-Disponibilidad geográfica limitada

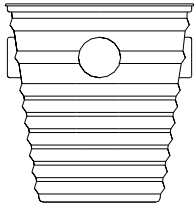

Pozo del sumidero

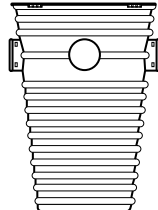

Pozo del sumidero

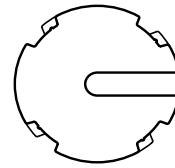

Tapas del sumidero con muescas y bloqueo



Tapa de sumidero estándar sin bloqueo

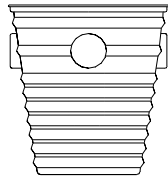

Pozo de radón

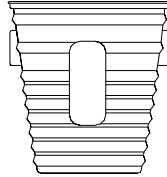

Pozo del sumidero del eyector



Tapa del sumidero sólida y sin bloquear

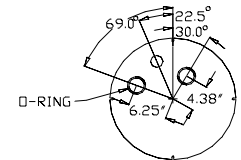

Kit de tapa sin bloqueo para eyector y sumidero de radón

PRODUCTOS DE DRENAJE DE CIMIENTOS

Descripción	Dimensiones	Código
14 gal. (53L) Revestimiento del sumidero	18" Diámetro x 24" Altura (450mm x 600mm)	1524ADH
19 gal. (72L) Revestimiento del sumidero	18" Diámetro x 30" Altura (450mm x 750mm)	1530ADH
14 gal. (53L) Revestimiento del sumidero	18" Diámetro x 24" Altura (450mm x 600mm)	1524ADL
19 gal. (72L) Revestimiento del sumidero	18" Diámetro x 30" Altura (450mm x 750mm)	1530ADL
Tapa de sumidero estándar sin bloqueo	18" Diámetro (450mm)	1536AD**
Tapa del sumidero sólida y sin bloquear	18" Diámetro (450mm)	1537AD**
Tapa de sumidero sólida con bloqueo	18" Diámetro (450mm)	1537ADL**
Tapa de sumidero con muesca y bloqueo	18" Diámetro (450mm)	1537ADNL**
Revestimiento ventilado doble para el radón	20" Diámetro x 24" Altura (500mm x 600mm)	1524ADR
Revestimiento de sumidero del eyector	20" Diámetro x 30" Altura (500mm x 750mm)	1530ADE
Kit de tapas sin bloqueo para eyector	20" Diámetro (500mm)	1530ADLX*

**Para uso con ADS 1524ADL y 1530ADL.

BANDERAS DE DISTRIBUCIÓN, CINTA NEGRA Y KITS DE SELLADO DE TUBOS DE VENTILACIÓN

Descripción	Longitudes disponibles	Código
Banderas de distribución	—	MR F00 00 0000
2" (50mm) Cinta negra	100 ft. (30.5m) roll	1137KA
1/2" (12.5mm) Cinta de filamento negro	100 ft. (30.5m) roll	1147KA
Kit de tubo de ventilación #1	—	VENT-TUBE-KIT1
Kit de tubo de ventilación #2	—	VENT-TUBE-KIT2

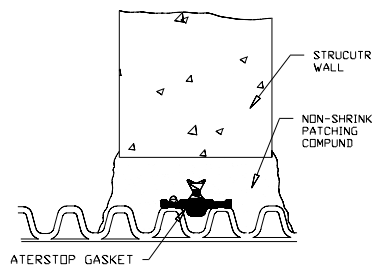
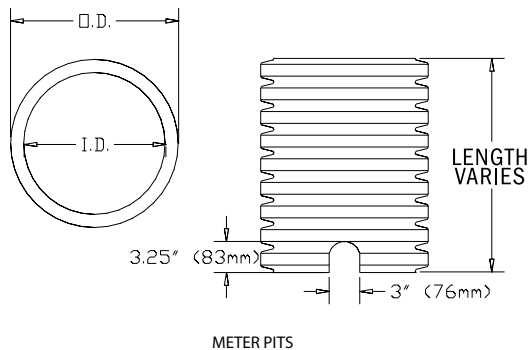

METER PITS

WATERSTOP GASKET

METER PITS*	
Dimensiones	Código
18" x 24" (450mm x 600mm)	1805ACH
18" x 30" (450mm x 750mm)	1805AAH
18" x 36" (450mm x 900mm)	1805ABH
18" x 42" (450mm x 1050mm)	1805ADH
18" x 48" (450mm x 1200mm)	1805AEH
21" x 24" (525mm x 600mm)	2105ACH
21" x 30" (525mm x 750mm)	2105AAH
21" x 36" (525mm x 900mm)	2105ABH
21" x 48" (525mm x 1200mm)	2105AEH
24" x 24" (600mm x 600mm)	2405ACH
24" x 30" (600mm x 750mm)	2405AAH
24" x 36" (600mm x 900mm)	2405ABH
24" x 42" (600mm x 1050mm)	2405ADH
24" x 48" (600mm x 1200mm)	2405AEH
18" x 12' (450mm x 3.5m) (UNCUT SECTION)	18050012H
21" x 12' (525mm x 3.5m) (UNCUT SECTION)	21050012H
24" x 12' (600mm x 3.5m) (UNCUT SECTION)	24050012H

EMPAQUES WATERSTOP			
Diámetros	Diámetro mínimo recomendado	Distancia mín. de inversión de tubería a inversión de estructura	Código
12" (300mm)	19.50" (495mm)	3.7" (94mm)	1202PS
15" (375mm)	23.00" (584mm)	4.0" (102mm)	1502PS
18" (450mm)	26.50" (673mm)	4.2" (107mm)	1802PS
24" (600mm)	33.25" (845mm)	4.5" (114mm)	2402PS
30" (750mm)	40.50" (1029mm)	5.2" (132mm)	3002PS
36" (900mm)	47.00" (1194mm)	5.5" (140mm)	3602PS
42" (1050mm)	53.00" (1346mm)	5.75" (146mm)	4202PS
48" (1200mm)	59.00" (1499mm)	5.75" (146mm)	4802PS
*54" (1350mm)	65.00" (1651mm)	6.4" (163mm)	5402PS
60" (1500mm)	72.00" (1829mm)	6.4" (163mm)	6002PS

- Disponibilidad geográfica limitada

- Todos los hoyos de los medidores son blancos y tienen muescas
Las secciones sin cortar no tienen muescas

PESO LIGERO - NO TEJIDO

Peso	Dimensiones	SY/ROLL	Código
3 oz. (85 g)	12.5' x 360' (3.8m x 109.7m)	500 (418 m2)	0311TG
3 oz. (85 g)	15' x 360' (4.6m x 109.7m)	600 (502 m2)	0311TS
3.5 oz. (99 g)	12.5' x 360' (3.8m x 109.7m)	500 (418 m2)	0351TG
3.5 oz. (99 g)	15' x 360' (4.6m x 109.7m)	600 (502 m2)	0351TS
4.0 oz. (113 g)	12.5' x 360' (3.8m x 109.7m)	500 (418 m2)	0401TG
4.0 oz. (113 g)	15' x 360' (4.6m x 109.7m)	600 (502 m2)	0401TS
4.5 oz. (128 g)	12.5' x 360' (3.8m x 109.7m)	500 (418 m2)	0451TG
4.5 oz. (128 g)	15' x 360' (4.6m x 109.7m)	600 (502 m2)	0451TS

PESO MEDIO - NO TEJIDO

Peso	Dimensiones	SY/ROLL	Código
6 oz. (170 g)	12.5' x 360' (3.8m x 109.7m)	500 (418 m2)	0601TG 0601TS
6 oz. (170 g)	15' x 300' (4.6m x 91.4m)	500 (418 m2)	0701TE 0701TG
7 oz. (198 g)	6' x 360' (1.8m x 109.7m)	240 (201 m2)	0701TS 0801TG
7 oz. (198 g)	12.5' x 360' (3.8m x 109.7m)	500 (418 m2)	0801TS
7 oz. (198 g)	15' x 300' (4.6m x 91.4m)	500 (418 m2)	
8 oz. (227 g)	12.5' x 360' (3.8m x 109.7m)	500 (418 m2)	
8 oz. (227 g)	15' x 300' (4.6m x 91.4m)	500 (418 m2)	

PESO PESADO - NO TEJIDO

Peso	Dimensiones	SY/ROLL	Código
10 oz. (284 g)	15' x 300' (4.6m x 91.4m)	500 (418 m2)	1001TS 1201TS
12 oz. (340 g)	15' x 300' (4.6m x 91.4m)	500 (418 m2)	1601TS
16 oz. (454 g)	15' x 300' (4.6m x 91.4m)	500 (418 m2)	

*ADDITIONAL WIDTHS AVAILABLE 2' (0.6 m), 3' (0.9 m), 4' (1.2 m), 7.5' (2.3 m).

TEJIDO DE ESTABILIZACIÓN SYR – TEJIDO

Agarre extensible	Dimensiones	SY/ROLL	Código
200	12.5' x 432' (3.8m x 131.7m)	600 (502 m2)	200WTK
200	15' x 360' (4.6m x 109.7m)	600 (502 m2)	200WTS
200	17.5' x 309' (5.3m x 94.2m)	600 (502 m2)	200WTM
250	12.5' x 360' (3.8m x 109.7m)	500 (418 m2)	250WTK
250	17.5' x 258' (5.3m x 78.6m)	500 (418 m2)	250WTM
270	12.5' x 360' (3.8m x 109.7m)	500 (418 m2)	270WTK
270	15' x 300' (4.6m x 91.4m)	500 (418 m2)	270WTS
270	17.5' x 258' (5.3m x 78.6m)	500 (418 m2)	270WTM
315	12.5' x 360' (3.8m x 109.7m)	500 (418 m2)	315WTK
315	15' x 300' (4.6m x 91.4m)	500 (418 m2)	315WTS
315	17.5' x 258' (5.3m x 78.6m)	500 (418 m2)	315WTM
465	12.5' x 360' (3.8m x 109.7m)	500 (418 m2)	315WTK

TEJIDO MONOFILAMENTO SYR – TEJIDO

Dimensiones	SY/ROLL	Código
12' x 300' (3.6m x 91.4m)	400 (334 m2)	104FWF
15' x 300' (4.6m x 91.4m)	500 (418 m2)	2x2HFTS
12.5' x 300' (3.8m x 91.4m)	417 (348 m2)	111FTK
12' x 300' (3.6m x 91.4m)	400 (334 m2)	117FTK

TEJIDO SYR DE RESISTENCIA MEDIA - TEJIDO

Dimensiones	SY/ROLL	Código
15' x 300' (4.6m x 91.4m)	500 (418 m ²)	270HPTS
17' x 258' (5.3m x 78.6m)	500 (418 m ²)	270HPTM
17.5' x 257' (5.3m x 78.3m)	500 (418 m ²)	370HPTS
15' x 300' (4.6m x 91.4m)	500 (418 m ²)	570HPTS

GEOMALLA BIAIXIAL

Dimensiones	SY/ROLL	Código
13.1' x 246' (4.0 m x 75.0 m)	359 (300 m2)	BX114GG
13.1' x 164' (4.0 m x 50.0 m)	239 (200m2)	BX124GG
13.1' x 164' (4.0m x 50.0m)	239 (200m2)	BX134GG
13.1' x 164' (4.0m x 50.0m)	239 (200m2)	BX154GG
13.1' x 246' (4.0m x 75.0m)	359 (300 m2)	BX414GG
13.1' x 328' (4.0m x 100m)	478 (400 m2)	BX2525GG
13.1' x 328' (4.0m x 100m)	478 (400 m2)	BX224GG
13.1' x 164' (4.0m x 50m)	239 (200 m2)	BX40404GG

GEOMALLA UNIAIXIAL

Dimensiones	SY/ROLL	Código
3.28' x 328' (1 m x 100 m)	120 (100 m2)	UX115GG
3.28' x 246' (1 m x 75 m)	90 (75m2)	UX145GG
3.28' x 164' (1 m x 50 m)	60 (50m2)	UX155GG
3.28' x 99' (1 m x 30 m)	36 (30m2)	UX165GG
3.28' x 99' (1 m x 30 m)	36 (30m2)	UX175GG

TEJIDO DE PAVIMENTACIÓN

Dimensiones	SY/ROLL	Código
12.5' x 360' (3.8m x 109.7m)	500 (418 m2)	4598TG
15' x 360' (4.6m x 109.7m)	600 (502 m2)	4598TS
12.5' x 360' (3.8m x 109.7m)	500 (418 m2)	4599TG
15' x 360' (4.6m x 109.7m)	600 (502 m2)	4599TS

SPUNBOND

Peso	Dimensiones	SY/ROLL	Código
1.5 oz. (43 g)	3' x 300' (.9m x 91.4m)	100 (84 m2)	3151TA 3151TB
1.5 oz. (43 g)	4' x 300' (1.2m x 91.4m)	133.33 (111 m2)	3151TE 3151TG
1.5 oz. (43 g)	6.3' x 300' (1.9m x 91.4m)	208.33 (174 m2)	3201TE 3201TA
1.5 oz. (43 g)	12.6' x 300' (3.8m x 91.4m)	420 (351 m2)	3201TB 3201TG
2.0 oz. (57 g)	6.3' x 300' (1.9m x 91.4m)	208 (174 m2)	3301TA
2.0 oz. (57 g)	3' x 300' (.9m x 91.4m)	100 (84 m2)	3301TB
2.0 oz. (57 g)	4' x 300' (1.2m x 91.4m)	133.33 (111 m2)	3301TE
2.0 oz. (57 g)	12.6' x 300' (3.8m x 91.4m)	420 (351 m2)	3301TT
3.0 oz. (85 g)	3' x 300' (.9m x 91.4m)	100 (84 m2)	3301TG
3.0 oz. (85 g)	4' x 300' (1.2m x 91.4m)	133.33 (111 m2)	3401TG 3401TH
3.0 oz. (85 g)	6.3' x 300' (1.9m x 91.4m)	208.33 (174 m2)	3601TG 3601TH
3.0 oz. (85 g)	9' x 300' (2.7m x 91.4m)	300 (247 m2)	
3.0 oz. (85 g)	12.6' x 300' (3.8m x 91.4m)	420 (351 m2)	
4.0 oz. (113 g)	12.6' x 300' (3.8m x 91.4m)	420 (351 m2)	
4.0 oz. (113 g)	15.6' x 300' (4.8m x 91.4m)	520 (435 m2)	
6.0 oz. (170 g)	3.8' x 300' (3.8m x 91m)	420 (351 m2)	
6.0 oz. (170 g)	15.6 x 300' (4.8m x 91m)	520 (435 m2)	

TELA SÉPTICA

Peso	Dimensiones	Código
0.45 oz. (13 g)	2' x 300' (.6m x 91.4m)	2624RB 2636RB
0.45 oz. (13 g)	3' x 300' (.9m x 91.4m)	2724RB 2736RB
0.45 oz. (13 g)	2' x 1500' (.6m x 457.2m)	2748RB 2760RB
0.45 oz. (13 g)	3' x 1500' (.9m x 457.2m)	2772RB
0.45 oz. (13 g)	4' x 1500' (1.2m x 457.2m)	
0.45 oz. (13 g)	5' x 1500' (1.5m x 457.2m)	
0.45 oz. (13 g)	6' x 1500' (1.8m x 457.2m)	

TELA SÉPTICA (TX)

Peso	Dimensiones	Código
0.7 oz. (13 g)	2' x 300' (.6m x 91.4m)	2824RB 2836RB
0.7 oz. (13 g)	3' x 300' (.9m x 91.4m)	2924RB 2936RB
0.7 oz. (13 g)	2' x 1500' (.6m x 457.2m)	2948RB 2972RB
0.7 oz. (13 g)	3' x 1500' (.9m x 457.2m)	
0.7 oz. (13 g)	4' x 1500' (1.2m x 457.2m)	
0.7 oz. (13 g)	6' x 1500' (1.8m x 457.2m)	

MANTAS DE CONTROL DE EROSION (ECB) - BIODEGRADABLE

Description	Dimensiones	SY/ROLL	Código
Single net straw	7.8' x 112.5' (2.4m x 34.3m)	100 (84 m2)	00S1TT
Double net straw	7.8' x 112.5' (2.4m x 34.3m)	100 (84 m2)	00S2TT
Coconut/Straw	7.8' x 112.5' (2.4m x 34.3m)	100 (84 m2)	0CS2TT
100% Coconut	7.8' x 112.5' (2.4m x 34.3m)	100 (84 m2)	00C2TT
Single net straw all natural	7.8' x 112.5' (2.4m x 34.3m)	100 (84 m2)	00S1AN
Double net straw all natural	7.8' x 112.5' (2.4m x 34.3m)	100 (84 m2)	00S2AN
Coconut/Straw all natural	7.8' x 112.5' (2.4m x 34.3m)	100 (84 m2)	0CS2AN
100% Coconut all natural	7.8' x 112.5' (2.4m x 34.3m)	100 (84 m2)	00C2AN

ALFOMBRA DE REFUERZO DE CÉSPED - PERMANENTE

Dimensiones	SY/ROLL	Código
7.5' x 120' (2.3m x 36.6m)	100 (84 m ²)	PP58GTR
7.5' x 120' (2.3m x 36.6m)	100 (84 m ²)	PP510GTR
7.5' x 120' (2.3m x 36.6m)	100 (84 m ²)	PP512GTR

ALFOMBRA DE REFUERZO DE CÉSPED DE ALTO RENDIMIENTO - PERMANENTE

Dimensiones	SY/ROLL	Código
8.5' x 109' (2.6m x 42.2m)	100 (84 m ²)	PP5XGTR

ALFILERES DE TELA

Dimensiones	Cantidad	Código
6" (50mm) Staple	1000/box	3206TP
12" (300mm) Pin	100/box	3212TP
18" (457mm) Pin	100/box	3218TP

VALLA DE LIMO

Descripción	Código
2' x 100' (.6m x 30m) rolls with 11 hardwood stakes per roll	3301WE
3' x 100' (.9m x 30m) rolls with 11 hardwood stakes per roll	3302WE
Premium Silt Fence - AASHTO 3' x 100' (.9m x 30m) with 17 hardwood stakes per roll	3302WP

ALFOMBRA DE SALIDA

Dimensiones	SY/ROLL	Código
12' x 75' (3.7m x 22.9m)	100 (83.6m ²)	OFM100



CONECTANDO GRANDES PROYECTOS®

Carr. a Villa de García km. 0.8, C.P. 66370, Santa Catarina, Nuevo León
Tel. (81) 8625 4500 / www.adsmexicana.com / [f](#) [in](#) [@](#) [■](#) ADS Mexicana