

Rinne / Channel:

FCT pro NW200 V-E

BG code: siehe Tabelle/ see table:

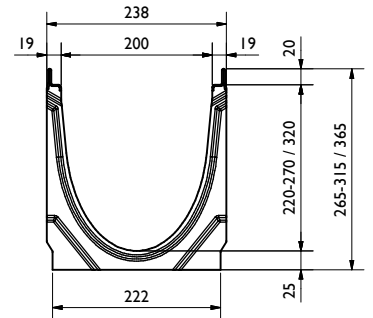
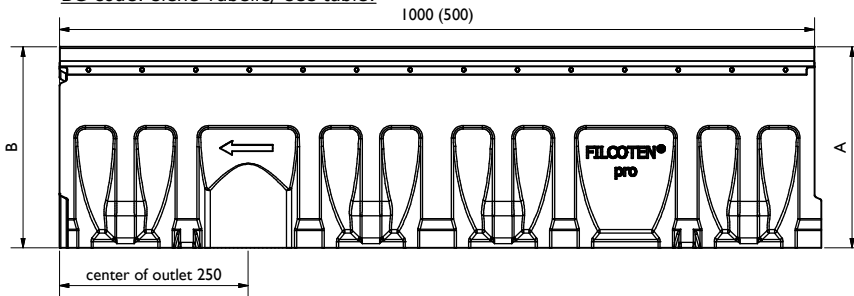

FCT pro NW200 G

BG code: siehe Tabelle/ see table:

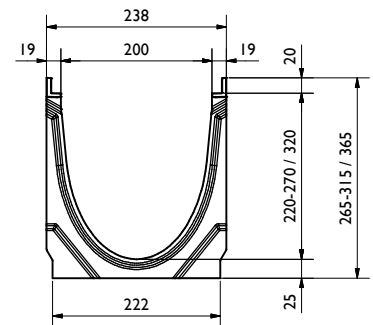
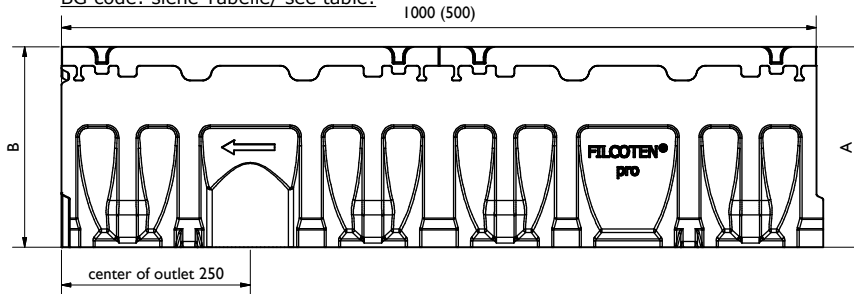

FCT pro NW200 V, Nr. 5-0 f. seitl. Bohrung/f. side outlet drilling

BG code: siehe Tabelle/ see table:

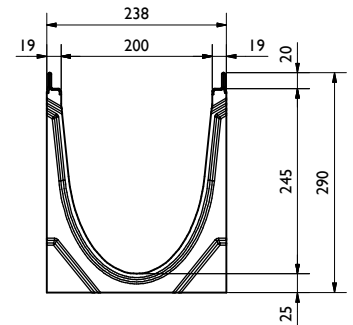
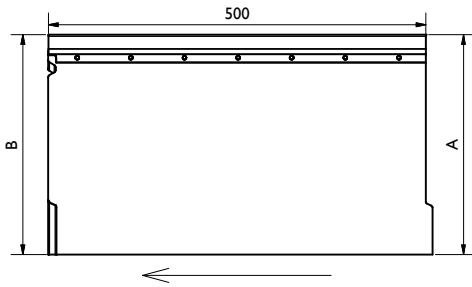

FCT pro NW200 G, Nr. 5-0 f. seitl. Bohrung/f. side outlet drilling

BG code: siehe Tabelle/ see table:

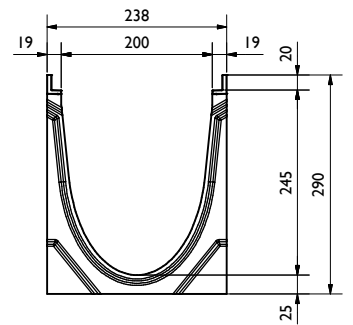
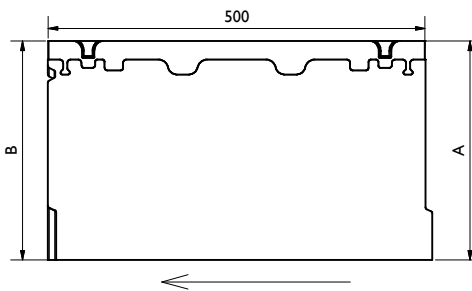

Rinne / channel - Maße / dimensions [mm]								
BG code G	BG code V	BG code E	Typ	Höhe A height A	Höhe B height B	Länge length	Gewicht weight G [kg]	Gewicht weight V/E [kg]
10620180	10620280	10620380	0 (0,5m)	265	265	500	22,6	22,1
10620101	10620201	10620301	1	265	270	1000	45,5	44,5
10620102	10620202	10620302	2	270	275	1000	46,5	45,5
10620103	10620203	10620303	3	275	280	1000	47,5	46,5
10620104	10620204	10620304	4	280	285	1000	48,6	47,5
10620105	10620205	10620305	5	285	290	1000	49,6	48,6
10620161	10620261	10620361	5-0	290	290	1000	50,3	49,3
10620181	10620281	10620381	5-0 (0,5m)	290	290	500	30,1	29,6
10620106	10620206	10620306	6	290	295	1000	50,7	49,7
10620107	10620207	10620307	7	295	300	1000	51,7	50,7
10620108	10620208	10620308	8	300	305	1000	52,8	51,8
10620109	10620209	10620309	9	305	310	1000	53,8	52,8
10620110	10620210	10620310	10	310	315	1000	54,9	53,9
10620162	10620262	10620362	10-0	315	315	1000	55,3	54,3
10620164	10620264	10620364	20-0	365	365	1000	65,6	64,6

Legende / explanation:	
FCT:	FILCOTEN HPC
V:	verzinkter Stahl / galvanized steel
E:	Edelstahl / stainless steel
G:	Gußbeisen / ductile iron
H:	Holz / wood

Roste, Abdeckungen / grates, covers:

Gitterrost / Mesh grating: MW30/10, C250
BG code: V 17020222 (17020223), E 17020322 (17020323); 8,8 kg (4,5 kg):

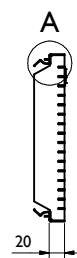
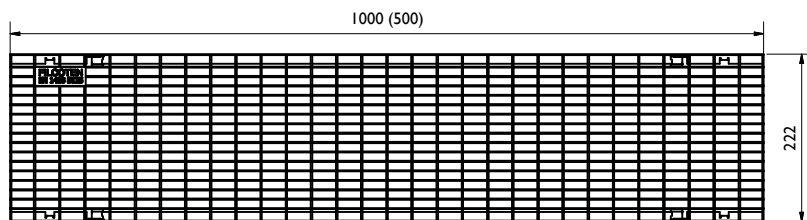

A (1:2)



Gitterrost / Mesh grating: MW25/10, D400
BG code: V 17020226 (17020227), E 17020326 (17020327); 15,7 kg (8 kg):

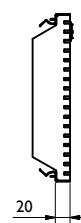
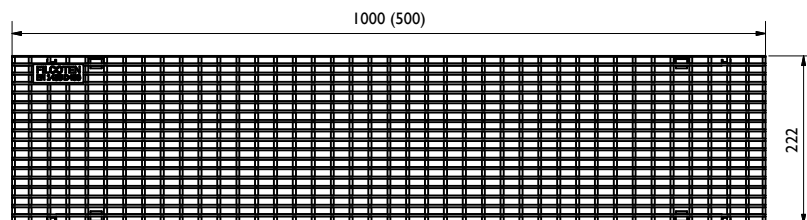

Lochrost / Perforated grating: Ø6, C250
BG code: V 17020228 (17020229), E 17020328 (17020329); 13,5 kg (6,7 kg):

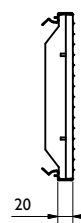
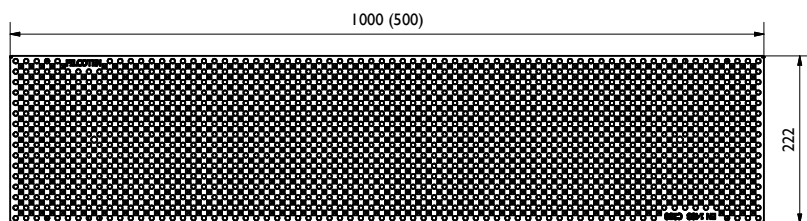

Roste, Abdeckungen / grates, covers:

Gußrost / Ductile iron grating: MW29/13, C250
BG code: GJS 17020101; 7,3 kg:

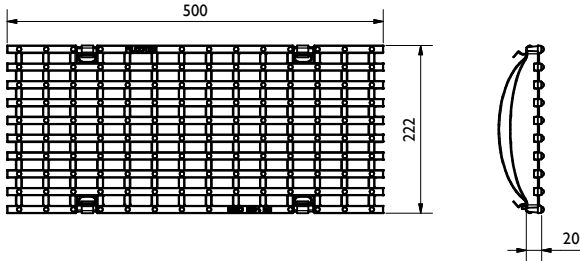

Gußrost / Ductile iron grating: MW29/13, D400
BG code: GJS 17020104; 7,6 kg:

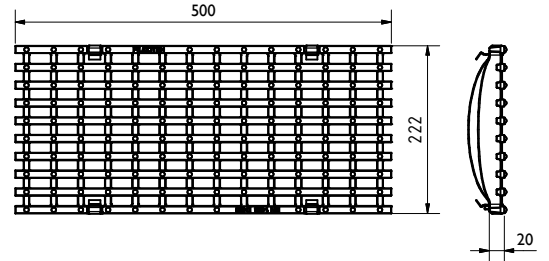

Gußrost / Ductile iron grating: KIARO, D400
BG code: GJS 17020183; 7,9 kg:

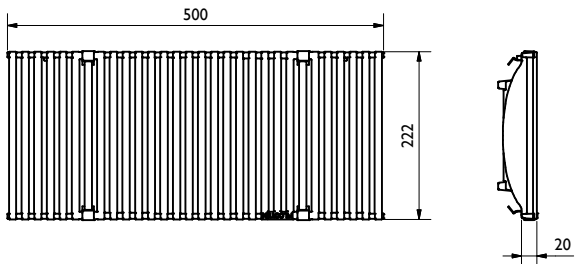

Gußrost / Ductile iron grating: VIA, D400
BG code: GJS 17020184; 8,2 kg:

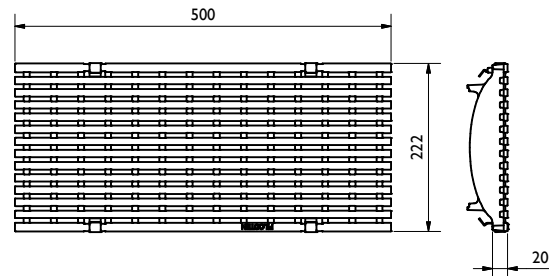

Guß-Stegrost / Ductile iron slotted grating: SW14/150, E600
BG code: GJS 17020105; 8,9 kg:

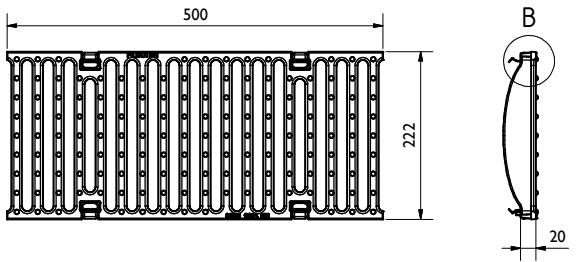

Guß-Designrost / Ductile iron design grating: VILLE, E600
BG code: GJS 17020180; 10,8 kg:

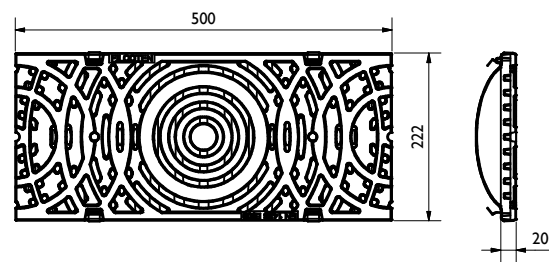

Guß-Stegrost / Ductile iron slotted grating: SW14/200, D400
BG code: GJS 17020108; 7,9 kg:
4-fach verschraubbar/4-times bolted

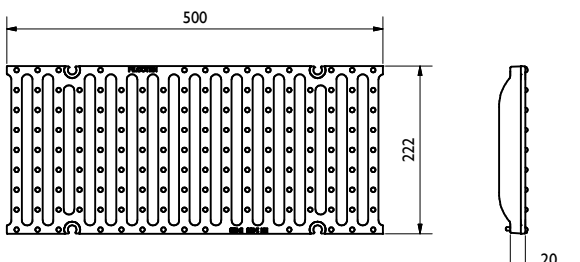

Gußrost / Ductile iron grating: MW22/13, E600
BG code: GJS 17020103; 8,8 kg:
4-fach verschraubbar/4-times bolted

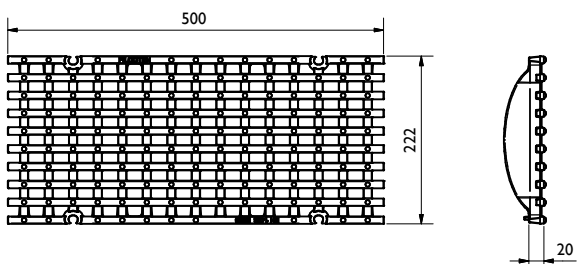

Gußrost / Ductile iron grating: SW2x14/95, F900
BG code: GJS 17020107; 12,3 kg:
4-fach verschraubbar/4-times bolted

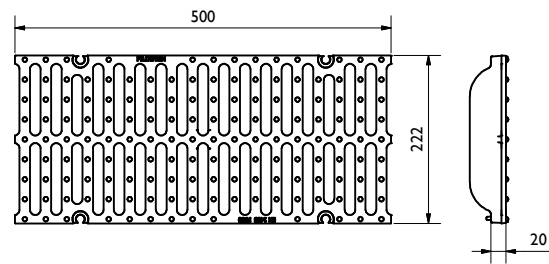

Zubehör / accessories:

Sinkkasten / Sump unit:
inkl. Schlammemeier / incl. silt bucket (22512; 0,7 kg)
BG code: V 10620292, E 10620392; 48,7 kg:

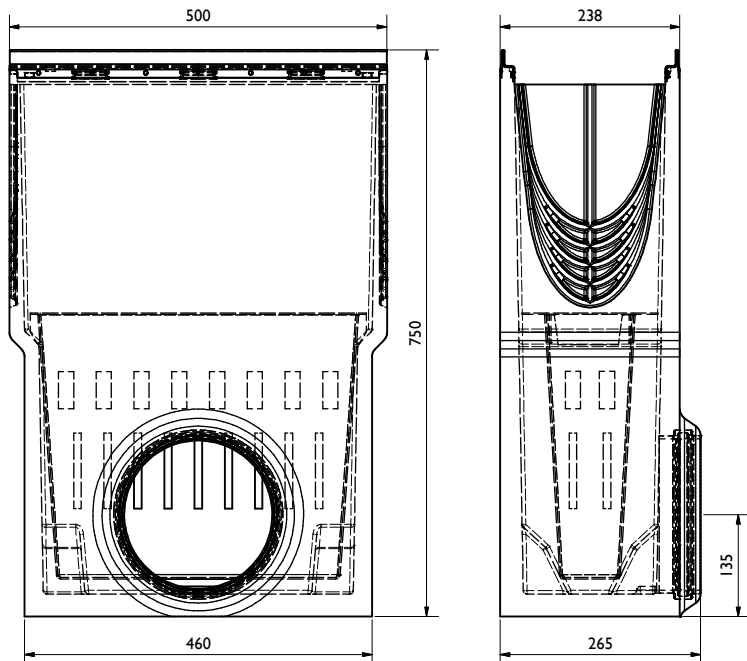

Stirn-/ Endplatte / End cap:
BG code: V 19020230, E 19020330; 0,8 kg:

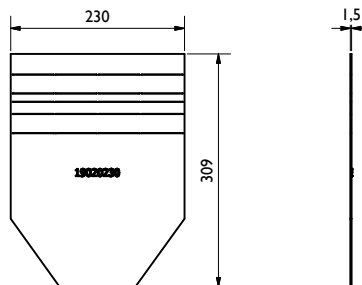

Stirn-/ Endplatte / End cap:
BG code: V 19020231, E 19020331; 1 kg:

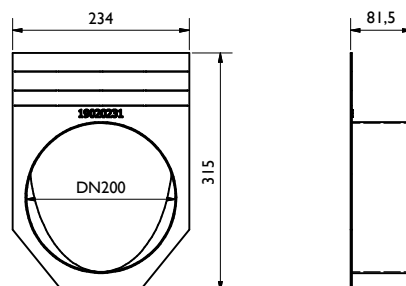

Sinkkasten / Sump unit:
inkl. Schlammemeier / incl. silt bucket (22512; 0,7 kg)
BG code: G 10620190; 49,1 kg:

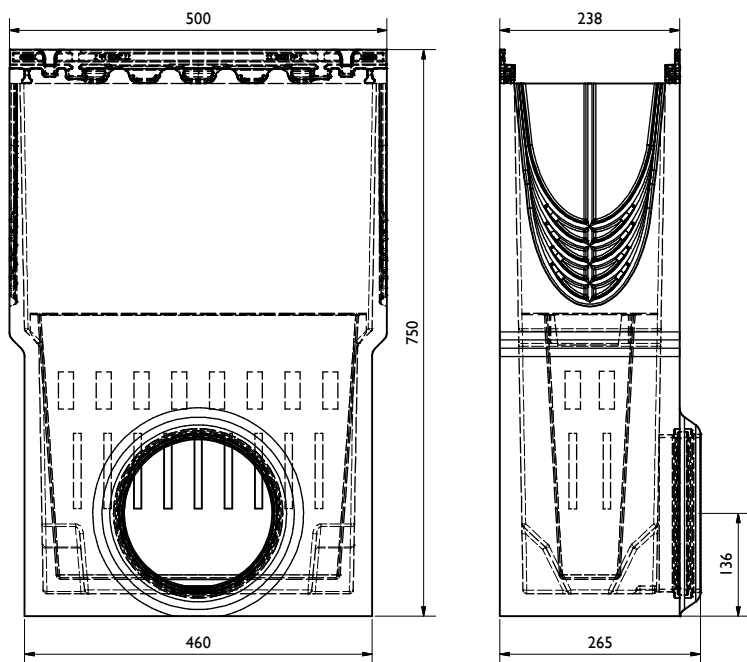

Vandalismus Verriegelung / Anti-vandalism locking device
BG code: 32089; 0,1 kg:

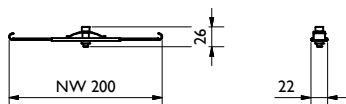

Verschraubungsmaterial / Bolting material:
BG code: V 32103; BG code: E 32109:

